

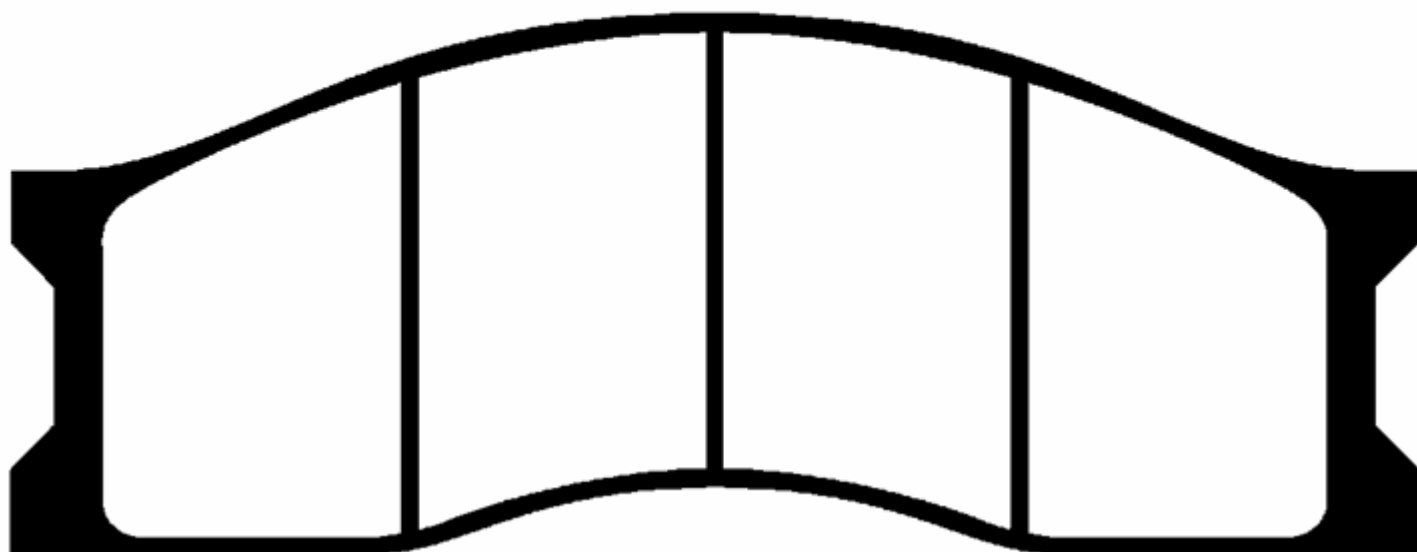

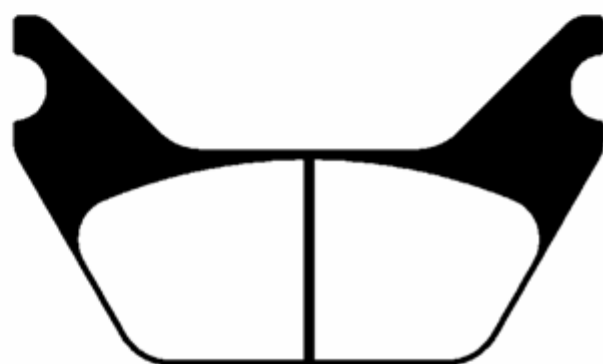

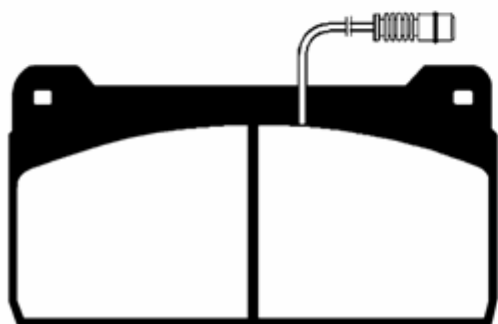

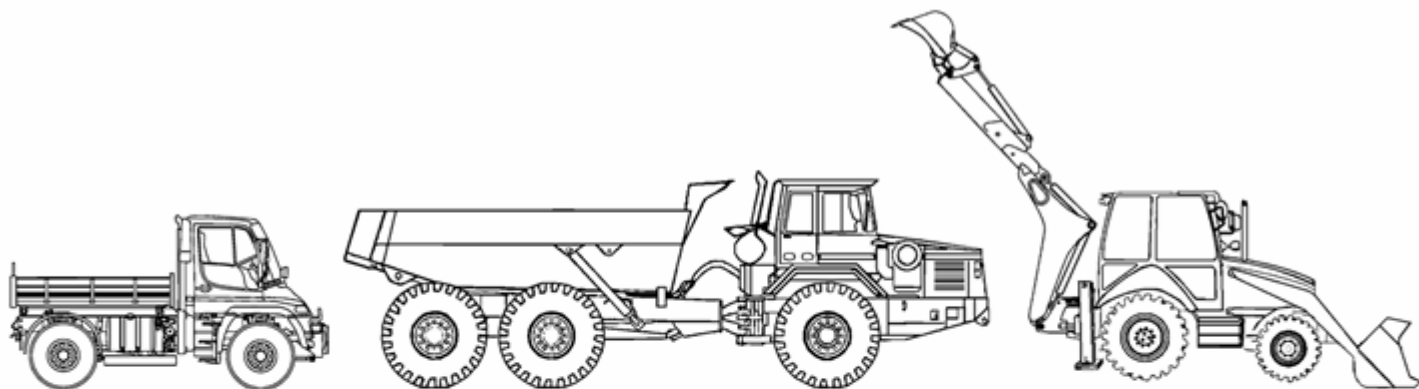

**CATALOGUE PLAQUETTES DE FREIN  
APPLICATIONS VEHICULES INDUSTRIELLES**

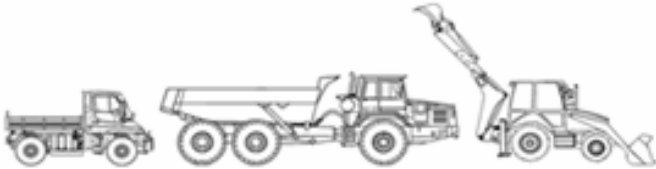
**BRAKE PADS CATALOG  
APPLICATIONS ON INDUSTRIAL VEHICLES**









<b>SOMMAIRE</b>	<b>PAGE</b>
<b>RECHERCHE RAPIDE (MARQUE et TYPE)</b>	<b>3-9</b>
<b>RECHERCHE PAR DIMENSIONS</b>	<b>10-11</b>
<b>DESSINS</b>	<b>12-33</b>
<b>CROSS REFERENCE</b>	<b>34-37</b>

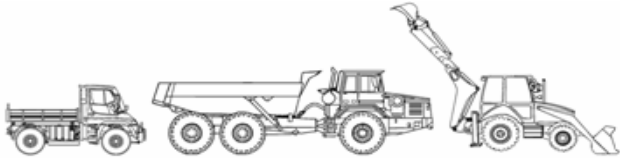





EXPLICATION DES SYMBOLES	
	MARQUES ET MODELES
	DATE
	SYSTEME
	LARGEUR
	HAUTEUR
	EPAISSEUR

EXPLICATION DES REFERENCES	
PSP	PLAQUETTES SPECIALES
	LARGEUR
001 - 099	De 47,2 à 99,99 mm
101 - 199	De 100,0 à 199,99 mm
201 - 299	De 200,0 à 299,99 mm
301 - 399	De 300,0 à 399,99 mm
401 - 499	De 400,0 à 499,99 mm







## APPLICATION PAR MODELES

							REF GIL
ALBARET	Isopactor			106,0	77,0	22,0	PSP102
ALBARET	Orthopactor		ROCKWELL	277,8	104,0	24,0	PSP210
ALSTOM	TRAM		KNORR	304,0	124,0	15,0	PSP301
ASTRA				114,5	101,0	12,5	PSP107
AVELING BARFORD	75 - 150 Dumper		AP	88,4	64,5	15,0	PSP006
AVELING BARFORD	SL 3 Dumper		AP	88,4	64,5	15,0	PSP006
AVELING BARFORD	FK, TS250			91,0	66,0	16,0	PSP011
AVELING BARFORD	TG 2A - 700 Super Grader T		GOODRICH	277,8	85,7	22,2	PSP209
AVELING BARFORD	RDO 040 050		ROCKWELL	277,8	104,0	24,0	PSP210
AVELING BARFORD			GOODRICH	321,0	108,3	25,0	PSP304
AVELING BARFORD	RD 55			445,0	143,0	25,0	PSP403
BELL				114,5	101,0	12,5	PSP107
BLAW KNOX	BK 195 MS 17			106,0	77,0	22,0	PSP102
BLAW KNOX	BK 350 MS 27			106,0	77,0	22,0	PSP102
BLAW KNOX	BK 395 MS 27			106,0	77,0	22,0	PSP102
BOLINDER MUNKTEL	GM 612 - GM 614		GOODRICH	277,8	85,7	22,2	PSP209
BOLINDER MUNKTEL	LM 218		GOODRICH	277,8	85,7	22,2	PSP209
BOLINDER MUNKTEL	SM 871 - SM 872		GOODRICH	277,8	85,7	22,2	PSP209
BOMBARDIER	TRAM		WABCO	200,0	127,0	20,0	PSP201
BONSER	40 H 40 cwt. 4 WD Dumper			177,0	74,0	22,5	PSP131
BREMBO			BREMBO	55,7	54,0	15,0	PSP002
BREMBO			BREMBO	61,8	57,0	15,0	PSP003
BREMBO			BREMBO	76,5	72,0	16,0	PSP005
BREMBO			BREMBO	90,0	76,0	17,0	PSP009
BREMBO			BREMBO	117,5	107,0	21,5	PSP110
BREMBO			BREMBO	117,5	107,0	21,5	PSP111
BREMBO			BREMBO	117,5	107,0	21,5	PSP112
BREMBO			BREMBO	117,5	117,5	22,0	PSP113
BREMBO			BREMBO	137,2	115,0	25,0	PSP117
C.M.C.				105,0	77,0	22,5	PSP101
C.M.C.	P10 - 20 - 30 Loaders			106,0	77,0	22,0	PSP102
CASE				105,0	77,0	22,5	PSP101
CASE	520 Loading Shovel	82-		106,0	77,0	22,0	PSP102
CASE	H 60 B			106,0	77,0	22,0	PSP102
CASE	Poclain C.M.C.p 10-20-30	82-		106,0	77,0	22,0	PSP102
CASE	W 18 - W 20	80-		106,0	77,0	22,0	PSP102
CASE	I 40	82-	PERROT	136,4	103,8	23,8	PSP116
CASE	W 14	83-		177,0	74,0	22,5	PSP131
CASE	530 - 540 - 550 Loader		GOODRICH	277,8	85,7	22,2	PSP209
CASE	W 14	83-	GOODRICH	277,8	85,7	22,2	PSP209
CASE	W 20 C		ROCKWELL	277,8	104,0	24,0	PSP210
CASE			GOODRICH	321,0	108,3	25,0	PSP304
CASE			GOODRICH	397,0	125,0	28,0	PSP311
CATERPILLAR				105,0	77,0	22,5	PSP101
CATERPILLAR	T 613 Tipper			106,0	77,0	22,0	PSP102
CATERPILLAR	FREIN DE PARKING			110,0	48,0		PSP106
CATERPILLAR				114,5	101,0	12,5	PSP107





## APPLICATION PAR MODELES

							REF GIL
<b>CATERPILLAR</b>	910 - 920 (3V 5465 F)			<b>177,0</b>	<b>74,0</b>	22,5	<b>PSP131</b>
<b>CATERPILLAR</b>				<b>260,0</b>	<b>88,0</b>	32,0	<b>PSP207</b>
<b>CATERPILLAR</b>	250 Dump Truck	82-	GOODRICH	<b>277,8</b>	<b>85,7</b>	22,2	<b>PSP209</b>
<b>CATERPILLAR</b>	505 - 511 - 521 A - 531	81-	GOODRICH	<b>277,8</b>	<b>85,7</b>	22,2	<b>PSP209</b>
<b>CATERPILLAR</b>	777 C Dump Truck		GOODRICH	<b>277,8</b>	<b>85,7</b>	22,2	<b>PSP209</b>
<b>CATERPILLAR</b>	910 - 920	82-	GOODRICH	<b>277,8</b>	<b>85,7</b>	22,2	<b>PSP209</b>
<b>CATERPILLAR</b>	930 - 950 - 950 B Shovel	82-	GOODRICH	<b>277,8</b>	<b>85,7</b>	22,2	<b>PSP209</b>
<b>CATERPILLAR</b>	700	83-	ROCKWELL	<b>277,8</b>	<b>104,0</b>	24,0	<b>PSP210</b>
<b>CATERPILLAR</b>			GOODRICH	<b>321,0</b>	<b>108,3</b>	25,0	<b>PSP304</b>
<b>CATERPILLAR</b>	41 K - 57 Z - 62 K	83-	GOODRICH	<b>326,0</b>	<b>102,0</b>	28,0	<b>PSP306</b>
<b>CATERPILLAR</b>	71 H - 73 V - 75 J	83-	GOODRICH	<b>326,0</b>	<b>102,0</b>	28,0	<b>PSP306</b>
<b>CATERPILLAR</b>	950 950 Model 43 - 11891	81-	GOODRICH	<b>326,0</b>	<b>102,0</b>	28,0	<b>PSP306</b>
<b>CATERPILLAR</b>	930 - 950 Loading Shovel	83-	GOODRICH	<b>397,0</b>	<b>125,0</b>	28,0	<b>PSP311</b>
<b>CATERPILLAR</b>	950B, 950 E tractor	83-	GOODRICH	<b>397,0</b>	<b>125,0</b>	28,0	<b>PSP311</b>
<b>CATERPILLAR</b>				<b>428,0</b>	<b>128,5</b>	25,0	<b>PSP402</b>
<b>CLARK MICHIGAN</b>				<b>91,0</b>	<b>66,0</b>	16,0	<b>PSP011</b>
<b>CLARK MICHIGAN</b>				<b>105,0</b>	<b>77,0</b>	22,5	<b>PSP101</b>
<b>CLARK MICHIGAN</b>	Michigan	81-		<b>106,0</b>	<b>77,0</b>	22,0	<b>PSP102</b>
<b>CLARK MICHIGAN</b>				<b>115,0</b>	<b>66,0</b>	16,0	<b>PSP108</b>
<b>CLARK MICHIGAN</b>				<b>277,0</b>	<b>86,0</b>		<b>PSP208</b>
<b>CLARK MICHIGAN</b>	275 C-280 C-320 B-745 C		GOODRICH	<b>277,8</b>	<b>85,7</b>	22,2	<b>PSP209</b>
<b>CLARK MICHIGAN</b>	45-50-75-125-172-175-275		GOODRICH	<b>277,8</b>	<b>85,7</b>	22,2	<b>PSP209</b>
<b>CLARK MICHIGAN</b>	475 CT		GOODRICH	<b>277,8</b>	<b>85,7</b>	22,2	<b>PSP209</b>
<b>CLARK MICHIGAN</b>	275 C-280 C-320 B-745 C		ROCKWELL	<b>277,8</b>	<b>104,0</b>	24,0	<b>PSP210</b>
<b>CLARK MICHIGAN</b>	45-50-75-125-172-175-275		ROCKWELL	<b>277,8</b>	<b>104,0</b>	24,0	<b>PSP210</b>
<b>CLARK MICHIGAN</b>	475 CT		ROCKWELL	<b>277,8</b>	<b>104,0</b>	24,0	<b>PSP210</b>
<b>CLARK MICHIGAN</b>	L 190	82-	ROCKWELL	<b>277,8</b>	<b>104,0</b>	24,0	<b>PSP210</b>
<b>CLARK MICHIGAN</b>			ROCKWELL	<b>321,0</b>	<b>155,0</b>	36,0	<b>PSP305</b>
<b>CLARK MICHIGAN</b>			GOODRICH	<b>326,0</b>	<b>102,0</b>	28,0	<b>PSP306</b>
<b>CLARK MICHIGAN</b>				<b>370,0</b>	<b>108,0</b>		<b>PSP308</b>
<b>CLARK MICHIGAN</b>			GOODRICH	<b>397,0</b>	<b>125,0</b>	28,0	<b>PSP311</b>
<b>CLARK MICHIGAN</b>			ROCKWELL	<b>412,6</b>	<b>131,7</b>	27,0	<b>PSP401</b>
<b>CLARK MICHIGAN</b>				<b>456,0</b>	<b>160,0</b>		<b>PSP404</b>
<b>CNH</b>	FREIN DE PARKING			<b>110,0</b>	<b>48,0</b>		<b>PSP106</b>
<b>CNH</b>				<b>260,0</b>	<b>88,0</b>	32,0	<b>PSP207</b>
<b>COLES</b>				<b>91,0</b>	<b>66,0</b>	16,0	<b>PSP011</b>
<b>DAVID BROWN</b>				<b>114,5</b>	<b>101,0</b>	12,5	<b>PSP107</b>
<b>DEUTZ</b>	5207,6207, DX			<b>154,0</b>	<b>90,0</b>	20,0	<b>PSP126</b>
<b>DUNLOP</b>			DUNLOP	<b>47,2</b>	<b>65,1</b>	17,0	<b>PSP001</b>
<b>EIMCO</b>			KNORR	<b>109,6</b>	<b>99,0</b>	25,0	<b>PSP104</b>
<b>EIMCO</b>	Under Ground Shovel	82-	GOODRICH	<b>277,8</b>	<b>85,7</b>	22,2	<b>PSP209</b>
<b>EIMCO</b>	Unit Rig		GOODRICH	<b>326,0</b>	<b>102,0</b>	28,0	<b>PSP306</b>
<b>EUCLID</b>				<b>260,0</b>	<b>88,0</b>	32,0	<b>PSP207</b>
<b>EUCLID</b>				<b>277,0</b>	<b>86,0</b>		<b>PSP208</b>
<b>EUCLID</b>			ROCKWELL	<b>321,0</b>	<b>155,0</b>	36,0	<b>PSP305</b>
<b>EUCLID</b>				<b>370,0</b>	<b>108,0</b>		<b>PSP308</b>
<b>EUCLID</b>	Maskiner	81-	GOODRICH	<b>397,0</b>	<b>125,0</b>	28,0	<b>PSP311</b>

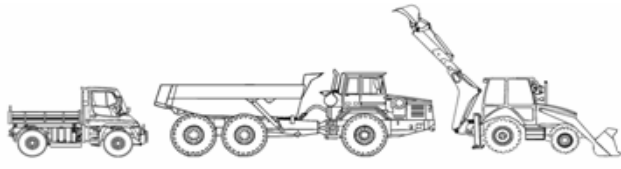

## APPLICATION PAR MODELES

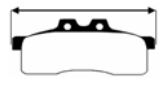
								REF GIL
EUCLID			GOODRICH	397,0	125,0	28,0	PSP311	
EUCLID			ROCKWELL	412,6	131,7	27,0	PSP401	
EUCLID				445,0	143,0	25,0	PSP403	
EUCLID				456,0	160,0		PSP404	
FAUN FRISCH			PERROT	108,0	45,0	16,0	PSP103	
FAUN FRISCH			GOODRICH	326,0	102,0	28,0	PSP306	
FAUN FRISCH	F1300 B			91,0	66,0	16,0	PSP011	
FAUN FRISCH				105,0	77,0	22,5	PSP101	
FAUN FRISCH			PERROT	136,0	103,8	24,0	PSP115	
FAUN FRISCH	F 1300 AP 9/M AXLE	83-	PERROT	136,4	103,8	23,8	PSP116	
FAUN FRISCH	F 1400 Shovel	83-	PERROT	136,4	103,8	23,8	PSP116	
FAUN FRISCH		82-	PERROT	151,2	114,4	26,0	PSP123	
FAUN FRISCH			PERROT	151,2	114,4	26,0	PSP124	
FAUN FRISCH	FK 20, FK1000	82-	GOODRICH	277,8	85,7	22,2	PSP209	
FAUN FRISCH			GOODRICH	397,0	125,0	28,0	PSP311	
FAUN FRISCH				445,0	143,0	25,0	PSP403	
FAWA			GOODRICH	277,8	85,7	22,2	PSP209	
FIAT ALLIS			BREMBO	55,7	54,0	15,0	PSP002	
FIAT ALLIS			BREMBO	61,8	57,0	15,0	PSP003	
FIAT ALLIS				105,0	77,0	22,5	PSP101	
FIAT ALLIS			GOODRICH	277,8	85,7	22,2	PSP209	
FIAT ALLIS			ROCKWELL	277,8	104,0	24,0	PSP210	
FRISCH SHOVEL	Essieu avec frein MESSIER			106,0	77,0	22,0	PSP102	
FRISCH SHOVEL	F 1300 B			132,2	103,8	24,0	PSP114	
FRISCH SHOVEL	F 1300 C AP 9M Axle			132,2	103,8	24,0	PSP114	
FRISCH SHOVEL	F 1400 Shovel			132,2	103,8	24,0	PSP114	
FRISCH SHOVEL	F 1300 B	82-	PERROT	136,4	103,8	23,8	PSP116	
FRISCH SHOVEL	F 1300 C AP 9M Axle	82-	PERROT	136,4	103,8	23,8	PSP116	
FRISCH SHOVEL	F 1400 Shovel	82-	PERROT	136,4	103,8	23,8	PSP116	
FRISCH SHOVEL	FK 20 - FK 1000		GOODRICH	277,8	85,7	22,2	PSP209	
FRISCH SHOVEL	Tipper Dumper FK 20	82-	GOODRICH	277,8	85,7	22,2	PSP209	
FURUKAWA				74,0	54,0	16,0	PSP004	
FURUKAWA	FI 330	80-		177,0	74,0	22,5	PSP131	
FURUKAWA				201,0	67,5	28,0	PSP202	
FURUKAWA	FL 230	80-	GOODRICH	277,8	85,7	22,2	PSP209	
FURUKAWA	FL 330	80-	GOODRICH	277,8	85,7	22,2	PSP209	
FURUKAWA	FL 120	82-		320,0	97,9	22,0	PSP303	
FURUKAWA			GOODRICH	321,0	108,3	25,0	PSP304	
FURUKAWA				334,0	81,0	25,0	PSP307	
GHH				105,0	77,0	22,5	PSP101	
GHH			GOODRICH	277,8	85,7	22,2	PSP209	
GOODRICH			GOODRICH	277,8	85,7	22,2	PSP209	
GOODRICH			GOODRICH	321,0	108,3	25,0	PSP304	
GOODRICH			GOODRICH	326,0	102,0	28,0	PSP306	
GOODRICH			GOODRICH	397,0	125,0	28,0	PSP311	
GOODYEAR			GOODYEAR	226,0	90,0	18,0	PSP205	
GROOT MODEL	Groot Model	81-	GOODRICH	277,8	85,7	22,2	PSP209	





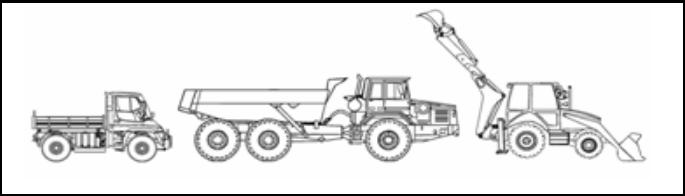

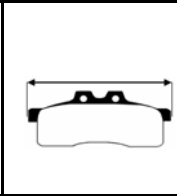
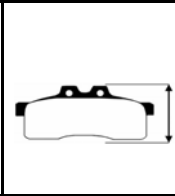
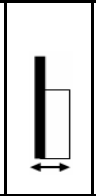
## APPLICATION PAR MODELES

								REF GIL
<b>GROVE WORLDWIDE</b>					<b>114,5</b>	<b>101,0</b>	12,5	<b>PSP107</b>
<b>GROVES</b>			DUNLOP		<b>47,2</b>	<b>65,1</b>	17,0	<b>PSP001</b>
<b>HANOMAG</b>					<b>74,0</b>	<b>54,0</b>	16,0	<b>PSP004</b>
<b>HANOMAG</b>					<b>89,5</b>	<b>63,5</b>	19,5	<b>PSP007</b>
<b>HANOMAG</b>			PERROT		<b>108,0</b>	<b>45,0</b>	16,0	<b>PSP103</b>
<b>HANOMAG</b>			PERROT		<b>136,0</b>	<b>103,8</b>	24,0	<b>PSP115</b>
<b>HANOMAG</b>	44	82-	PERROT		<b>136,4</b>	<b>103,8</b>	23,8	<b>PSP116</b>
<b>HANOMAG</b>	66		PERROT		<b>136,4</b>	<b>103,8</b>	23,8	<b>PSP116</b>
<b>HANOMAG</b>	44		PERROT		<b>151,2</b>	<b>114,4</b>	26,0	<b>PSP123</b>
<b>HANOMAG</b>	60, 66 D	82-	PERROT		<b>151,2</b>	<b>114,4</b>	26,0	<b>PSP123</b>
<b>HANOMAG</b>			PERROT		<b>151,2</b>	<b>114,4</b>	26,0	<b>PSP124</b>
<b>HANOMAG</b>		82-	PERROT		<b>162,2</b>	<b>111,3</b>	27,5	<b>PSP128</b>
<b>HANOMAG</b>			PERROT		<b>162,2</b>	<b>111,3</b>	27,5	<b>PSP130</b>
<b>HANOMAG</b>	70 E	81-	ROCKWELL		<b>277,8</b>	<b>104,0</b>	24,0	<b>PSP210</b>
<b>IHC DRESSER</b>					<b>91,0</b>	<b>66,0</b>	16,0	<b>PSP011</b>
<b>IHC DRESSER</b>					<b>105,0</b>	<b>77,0</b>	22,5	<b>PSP101</b>
<b>IHC DRESSER</b>	520 Loading Shovel	80-			<b>106,0</b>	<b>77,0</b>	22,0	<b>PSP102</b>
<b>IHC DRESSER</b>			PERROT		<b>136,0</b>	<b>103,8</b>	24,0	<b>PSP115</b>
<b>IHC DRESSER</b>	540, MF44C, 55C, 65, 66C	80-	PERROT		<b>136,4</b>	<b>103,8</b>	23,8	<b>PSP116</b>
<b>IHC DRESSER</b>			GOODRICH		<b>277,8</b>	<b>85,7</b>	22,2	<b>PSP209</b>
<b>IHC DRESSER</b>			GOODRICH		<b>326,0</b>	<b>102,0</b>	28,0	<b>PSP306</b>
<b>IHC DRESSER</b>			GOODRICH		<b>397,0</b>	<b>125,0</b>	28,0	<b>PSP311</b>
<b>INBUS</b>		82-	PERROT		<b>162,2</b>	<b>111,3</b>	27,5	<b>PSP128</b>
<b>JARVIS CLARK</b>			GOODRICH		<b>277,8</b>	<b>85,7</b>	22,2	<b>PSP209</b>
<b>JARVIS CLARK</b>			GOODRICH		<b>397,0</b>	<b>125,0</b>	28,0	<b>PSP311</b>
<b>JCB</b>	300, 300T				<b>91,0</b>	<b>66,0</b>	16,0	<b>PSP011</b>
<b>JCB</b>	2 D - 3 CD, 423	84-			<b>177,0</b>	<b>74,0</b>	22,5	<b>PSP131</b>
<b>JCB</b>	413 - 418	84-	GOODRICH		<b>277,8</b>	<b>85,7</b>	22,2	<b>PSP209</b>
<b>JCB</b>	423 - 427 - 428	84-	GOODRICH		<b>277,8</b>	<b>85,7</b>	22,2	<b>PSP209</b>
<b>JCB</b>	JCB 2 D - 3 CD	84-	GOODRICH		<b>277,8</b>	<b>85,7</b>	22,2	<b>PSP209</b>
<b>JCB</b>			GOODRICH		<b>321,0</b>	<b>108,3</b>	25,0	<b>PSP304</b>
<b>KAEBLE</b>		82-	PERROT		<b>151,2</b>	<b>114,4</b>	26,0	<b>PSP123</b>
<b>KAEBLE</b>			PERROT		<b>151,2</b>	<b>114,4</b>	26,0	<b>PSP124</b>
<b>KALI &amp; SALZ</b>			GOODRICH		<b>397,0</b>	<b>125,0</b>	28,0	<b>PSP311</b>
<b>KASSBOHRER</b>	Kassbohrer		KNORR		<b>139,0</b>	<b>121,0</b>	32,0	<b>PSP120</b>
<b>KÄSSBOHRER</b>		82-	PERROT		<b>162,2</b>	<b>111,3</b>	27,5	<b>PSP128</b>
<b>KÄSSBOHRER</b>	2V20		KNORR		<b>180,0</b>	<b>113,0</b>	20,0	<b>PSP132</b>
<b>KÄSSBOHRER</b>			KNORR		<b>258,3</b>	<b>112,5</b>	18,0	<b>PSP206</b>
<b>KÄSSBOHRER</b>			ATE		<b>385,0</b>	<b>140,5</b>	29,0	<b>PSP310</b>
<b>KAWASAKI</b>					<b>90,0</b>	<b>102,0</b>	23,0	<b>PSP010</b>
<b>KAWASAKI</b>	FREIN DE PARKING				<b>110,0</b>	<b>48,0</b>		<b>PSP106</b>
<b>KAWASAKI</b>	KSS 652 Loader				<b>177,0</b>	<b>74,0</b>	22,5	<b>PSP131</b>
<b>KAWASAKI</b>					<b>201,0</b>	<b>67,5</b>	28,0	<b>PSP202</b>
<b>KAWASAKI</b>	4 IDB 114	80-			<b>220,0</b>	<b>79,0</b>	22,0	<b>PSP204</b>
<b>KAWASAKI</b>	KSS 70 Scraper	82-	GOODRICH		<b>277,8</b>	<b>85,7</b>	22,2	<b>PSP209</b>
<b>KAWASAKI</b>	4 IDB 114	80-			<b>320,0</b>	<b>97,9</b>	22,0	<b>PSP303</b>
<b>KAWASAKI</b>					<b>334,0</b>	<b>81,0</b>	25,0	<b>PSP307</b>

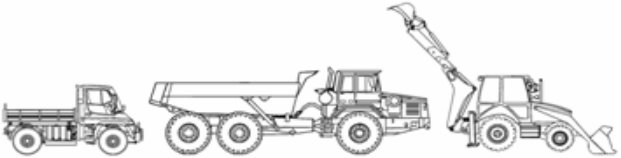
## APPLICATION PAR MODELES







							REF GIL
KNORR	K65		KNORR	109,6	99,0	25,0	PSP104
KNORR	K85		KNORR	139,0	121,0	32,0	PSP120
KNORR	2V20		KNORR	180,0	113,0	20,0	PSP132
KNORR	1V20		KNORR	258,3	112,5	18,0	PSP206
KNORR	TRAM		KNORR	304,0	124,0	15,0	PSP301
KOCKUM				105,0	77,0	22,5	PSP101
KOCKUM	K 412	81-		106,0	77,0	22,0	PSP102
KOCKUM	K 555		ROCKWELL	277,8	104,0	24,0	PSP210
KOMATSU-DRESSER	Articulated Dump Truck		KNORR	139,0	121,0	32,0	PSP120
KOMATSU-DRESSER				260,0	88,0	32,0	PSP207
KOMATSU-DRESSER				277,0	86,0		PSP208
KOMATSU-DRESSER			ROCKWELL	277,8	104,0	24,0	PSP210
KOMATSU-DRESSER	W 90 - W 120 - W 180	81-		320,0	97,9	22,0	PSP303
KOMATSU-DRESSER			ROCKWELL	321,0	155,0	36,0	PSP305
KOMATSU-DRESSER				370,0	108,0		PSP308
KOMATSU-DRESSER			ROCKWELL	412,6	131,7	27,0	PSP401
KOMATSU-DRESSER				456,0	160,0		PSP404
LANDINI	Tractor	82-		106,0	77,0	22,0	PSP102
LANDSWERK				105,0	77,0	22,5	PSP101
LIEBHERR			PERROT	136,0	103,8	24,0	PSP115
LIEBHERR			PERROT	136,4	103,8	23,8	PSP116
LIEBHERR	1025LTM, 1030, MF		PERROT	151,2	114,4	26,0	PSP123
LIEBHERR			PERROT	151,2	114,4	26,0	PSP124
MAGIRUS DEUTZ			KNORR	109,6	99,0	25,0	PSP104
MASSEY FERGUSON				105,0	77,0	22,5	PSP101
MASSEY FERGUSON	33 - 44 - 44 B - 55	81-		106,0	77,0	22,0	PSP102
MASSEY FERGUSON	66 Tractor	81-		106,0	77,0	22,0	PSP102
MASSEY FERGUSON	44 C - 55 C - 65 C - 66 C	80-		132,2	103,8	24,0	PSP114
MASSEY FERGUSON	66 C Wheeled TP Engine	80-		132,2	103,8	24,0	PSP114
MASSEY FERGUSON			PERROT	136,0	103,8	24,0	PSP115
MASSEY FERGUSON	44 C - 55 C - 65 C	80-	PERROT	136,4	103,8	23,8	PSP116
MASSEY FERGUSON	66 C Wheeled Loader	80-	PERROT	136,4	103,8	23,8	PSP116
MASSEY FERGUSON	44 C - 55 C - 65 C - 66 C	80-	PERROT	151,2	114,4	26,0	PSP123
MASSEY FERGUSON			PERROT	151,2	114,4	26,0	PSP124
MENARINI	MONOCAR		BREMBO	117,5	107,0	21,5	PSP110
MENARINI	MONOCAR		BREMBO	117,5	107,0	21,5	PSP111
MENARINI	101		BREMBO	117,5	107,0	21,5	PSP112
MENARINI	MONOCAR 101		BREMBO	117,5	117,5	22,0	PSP113
MENARINI	MONOCAR 101 L		BREMBO	117,5	117,5	22,0	PSP113
MENARINI	MONOCAR 201 - 220		BREMBO	117,5	117,5	22,0	PSP113
MENARINI URBANO				117,0	83,0	19,0	PSP109
MESSIER				105,0	77,0	22,5	PSP101
MITSUI				201,0	67,5	28,0	PSP202
MITSUI				334,0	81,0	25,0	PSP307
NACCO-HYSTER			ROCKWELL	370,8	130,0	27,5	PSP309
O & K				105,0	77,0	22,5	PSP101
O & K			PERROT	136,0	103,8	24,0	PSP115

# APPLICATION PAR MODELES

								REF GIL
O & K				PERROT	136,4	103,8	23,8	PSP116
O & K		82-		PERROT	151,2	114,4	26,0	PSP123
O & K				PERROT	151,2	114,4	26,0	PSP124
O & K					260,0	88,0	32,0	PSP207
O & K					428,0	128,5	25,0	PSP402
O & K					445,0	143,0	25,0	PSP403
O & K					456,0	160,0		PSP404
P & H					110,0	38,0	11,0	PSP105
PALA ROSSI				BREMBO	90,0	76,0	17,0	PSP009
PALA ROSSI					117,0	83,0	19,0	PSP109
PERROT				PERROT	108,0	45,0	16,0	PSP103
PERROT	Perrot	80-			132,2	103,8	24,0	PSP114
PERROT				PERROT	136,0	103,8	24,0	PSP115
PERROT				PERROT	136,4	103,8	23,8	PSP116
PERROT				PERROT	137,7	82,0	11,0	PSP118
PERROT				PERROT	137,7	82,0	14,0	PSP119
PERROT	Perrot	80-		PERROT	147,0	116,0	26,0	PSP121
PERROT		82-		PERROT	151,2	114,4	26,0	PSP123
PERROT				PERROT	151,2	114,4	26,0	PSP124
PERROT				PERROT	153,9	96,5	25,0	PSP125
PERROT	485F-Ö	82-		PERROT	162,2	111,3	27,5	PSP128
PERROT	INBUS			PERROT	162,2	111,3	27,5	PSP129
PERROT				PERROT	162,2	111,3	27,5	PSP130
PERROT				PERROT	208,6	91,5	17,7	PSP203
POCLAIN					105,0	77,0	22,5	PSP101
POCLAIN	Model P 10 - P 20				106,0	77,0	22,0	PSP102
RICHIER					105,0	77,0	22,5	PSP101
ROCKWELL				GOODYEAR	226,0	90,0	18,0	PSP205
ROCKWELL				ROCKWELL	277,8	104,0	24,0	PSP210
ROCKWELL				ROCKWELL	321,0	155,0	36,0	PSP305
ROCKWELL				ROCKWELL	370,8	130,0	27,5	PSP309
ROCKWELL				ROCKWELL	412,6	131,7	27,0	PSP401
SCHOPF				PERROT	136,0	103,8	24,0	PSP115
SCHOPF				PERROT	136,4	103,8	23,8	PSP116
SCHOPF		82-		PERROT	151,2	114,4	26,0	PSP123
SCHOPF				PERROT	151,2	114,4	26,0	PSP124
SIME					159,0	110,0	14,0	PSP127
SIME					315,0	110,0	14,0	PSP302
SOMA E.T.					105,0	77,0	22,5	PSP101
TEREX	FREIN DE PARKING				110,0	48,0		PSP106
TEREX					260,0	88,0	32,0	PSP207
TEREX					277,0	86,0		PSP208
TEREX				GOODRICH	277,8	85,7	22,2	PSP209
TEREX				GOODRICH	321,0	108,3	25,0	PSP304
TEREX				ROCKWELL	321,0	155,0	36,0	PSP305
TEREX				ROCKWELL	370,8	130,0	27,5	PSP309
TEREX					428,0	128,5	25,0	PSP402







# APPLICATION PAR MODELES

							REF GIL
TEREX				445,0	143,0	25,0	PSP403
TEREX				456,0	160,0		PSP404
TROJAN			GOODRICH	277,8	85,7	22,2	PSP209
UNIMOG			ATE	89,7	73,8	15,0	PSP008
UNIMOG			ATE	149,6	81,5	20,3	PSP122
UNIT RING			KNORR	109,6	99,0	25,0	PSP104
UNIT RING				277,0	86,0		PSP208
UNIT RING			ROCKWELL	321,0	155,0	36,0	PSP305
UNIT RING				370,0	108,0		PSP308
VALMET				428,0	128,5	25,0	PSP402
VME				260,0	88,0	32,0	PSP207
VME				445,0	143,0	25,0	PSP403
VOEST ALPIN				105,0	77,0	22,5	PSP101
VOLVO	SM 462			91,0	66,0	16,0	PSP011
VOLVO				105,0	77,0	22,5	PSP101
VOLVO				114,5	101,0	12,5	PSP107
VOLVO	A35C		KNORR	139,0	121,0	32,0	PSP120
VOLVO				177,0	74,0	22,5	PSP131
VOLVO				260,0	88,0	32,0	PSP207
VOLVO	LM218		GOODRICH	277,8	85,7	22,2	PSP209
VOLVO	4300, 4400, 4500, 4600, 5350		ROCKWELL	277,8	104,0	24,0	PSP210
VOLVO	A35		ROCKWELL	370,8	130,0	27,5	PSP309
WABCO	TRAM		WABCO	200,0	127,0	20,0	PSP201
WAGNER MINING			GOODRICH	277,8	85,7	22,2	PSP209
WAGNER MINING			GOODRICH	397,0	125,0	28,0	PSP311
WERKLUST				105,0	77,0	22,5	PSP101
ZETTELMAYER				105,0	77,0	22,5	PSP101
ZETTELMAYER			PERROT	136,0	103,8	24,0	PSP115
ZETTELMAYER			PERROT	136,4	103,8	23,8	PSP116
ZETTELMAYER		82-	PERROT	151,2	114,4	26,0	PSP123
ZETTELMAYER			PERROT	151,2	114,4	26,0	PSP124
ZETTELMAYER			ROCKWELL	277,8	104,0	24,0	PSP210
ZETTELMAYER			GOODRICH	397,0	125,0	28,0	PSP311

## RECHERCHE PAR DIMENSIONS

			REF GIL		OBSERVATION
47,2	65,1	17,0	<b>PSP001</b>	DUNLOP	
55,7	54,0	15,0	<b>PSP002</b>	BREMBO	
61,8	57,0	15,0	<b>PSP003</b>	BREMBO	
74,0	54,0	16,0	<b>PSP004</b>		
76,5	72,0	16,0	<b>PSP005</b>	BREMBO	
88,4	64,5	15,0	<b>PSP006</b>	AP	
89,5	63,5	19,5	<b>PSP007</b>		
89,7	73,8	15,0	<b>PSP008</b>	ATE	4 ou 8 Pièces
90,0	76,0	17,0	<b>PSP009</b>	BREMBO	
90,0	102,0	23,0	<b>PSP010</b>		
91,0	66,0	16,0	<b>PSP011</b>		
105,0	77,0	22,5	<b>PSP101</b>		Avec TU
106,0	77,0	22,0	<b>PSP102</b>		
108,0	45,0	16,0	<b>PSP103</b>	PERROT	
109,6	99,0	25,0	<b>PSP104</b>	KNORR	
110,0	38,0	11,0	<b>PSP105</b>		
110,0	48,0		<b>PSP106</b>		
114,5	101,0	12,5	<b>PSP107</b>		
115,0	66,0	16,0	<b>PSP108</b>		
117,0	83,0	19,0	<b>PSP109</b>		
117,5	107,0	21,5	<b>PSP110</b>	BREMBO	Avec TU (1 cosse)
117,5	107,0	21,5	<b>PSP111</b>	BREMBO	Avec TU (2 cosses)
117,5	107,0	21,5	<b>PSP112</b>	BREMBO	Avec TU (2 cosses)
117,5	117,5	22,0	<b>PSP113</b>	BREMBO	
132,2	103,8	24,0	<b>PSP114</b>		
136,0	103,8	24,0	<b>PSP115</b>	PERROT	Avec TU
136,4	103,8	23,8	<b>PSP116</b>	PERROT	
137,2	115,0	25,0	<b>PSP117</b>	BREMBO	
137,7	82,0	11,0	<b>PSP118</b>	PERROT	
137,7	82,0	14,0	<b>PSP119</b>	PERROT	
139,0	121,0	32,0	<b>PSP120</b>	KNORR	
147,0	116,0	26,0	<b>PSP121</b>	PERROT	
149,6	81,5	20,3	<b>PSP122</b>	ATE	4 ou 8 pièces + TU
151,2	114,4	26,0	<b>PSP123</b>	PERROT	
151,2	114,4	26,0	<b>PSP124</b>	PERROT	Avec TU
153,9	96,5	25,0	<b>PSP125</b>	PERROT	
154,0	90,0	20,0	<b>PSP126</b>		Avec TU
159,0	110,0	14,0	<b>PSP127</b>		
162,2	111,3	27,5	<b>PSP128</b>	PERROT	
162,2	111,3	27,5	<b>PSP129</b>	PERROT	
162,2	111,3	27,5	<b>PSP130</b>	PERROT	Avec TU
177,0	74,0	22,5	<b>PSP131</b>		
180,0	113,0	20,0	<b>PSP132</b>	KNORR	
200,0	127,0	20,0	<b>PSP201</b>	WABCO	
201,0	67,5	28,0	<b>PSP202</b>		
208,6	91,5	17,7	<b>PSP203</b>	PERROT	
220,0	79,0	22,0	<b>PSP204</b>		
226,0	90,0	18,0	<b>PSP205</b>	GOODYEAR	

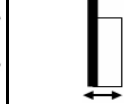
## RECHERCHE PAR DIMENSIONS

			<b>REF GIL</b>		<b>OBSERVATION</b>
258,3	112,5	18,0	<b>PSP206</b>	KNORR	
260,0	88,0	32,0	<b>PSP207</b>		
277,0	86,0		<b>PSP208</b>		
277,8	85,7	22,2	<b>PSP209</b>	GOODRICH	
277,8	104,0	24,0	<b>PSP210</b>	ROCKWELL	
304,0	124,0	15,0	<b>PSP301</b>	KNORR	
315,0	110,0	14,0	<b>PSP302</b>		
320,0	97,9	22,0	<b>PSP303</b>		
321,0	108,3	25,0	<b>PSP304</b>	GOODRICH	G + D
321,0	155,0	36,0	<b>PSP305</b>	ROCKWELL	
326,0	102,0	28,0	<b>PSP306</b>	GOODRICH	G + D
334,0	81,0	25,0	<b>PSP307</b>		
370,0	108,0		<b>PSP308</b>		
370,8	130,0	27,5	<b>PSP309</b>	ROCKWELL	
385,0	140,5	29,0	<b>PSP310</b>	ATE	
397,0	125,0	28,0	<b>PSP311</b>	GOODRICH	G + D
412,6	131,7	27,0	<b>PSP401</b>	ROCKWELL	
428,0	128,5	25,0	<b>PSP402</b>		G + D
445,0	143,0	25,0	<b>PSP403</b>		G + D
456,0	160,0		<b>PSP404</b>		

Automotive

**PSP001**

47,2x65,1x17,0

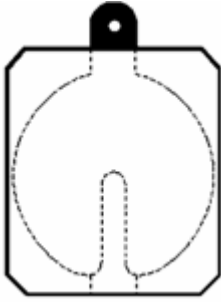

**PSP002**

55,7x54,0x15,0



**PSP003**

61,8x57,0x15,0

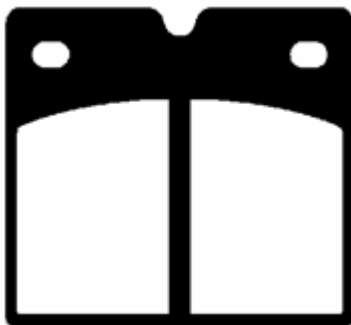

**PSP004**

74,0x54,0x16,0

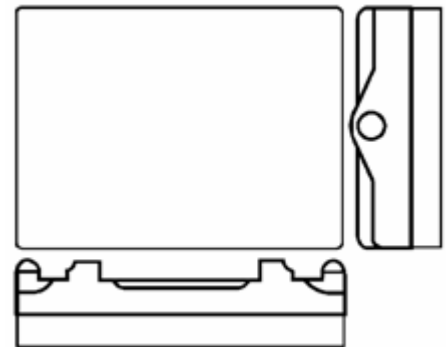

**PSP005**

76,5x72,0x16,0

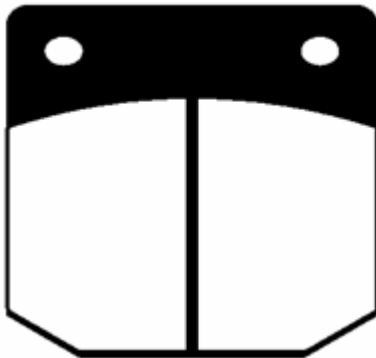

**PSP006**

88,4x64,5x15,0



**PSP007**

89,5x63,5x19,5

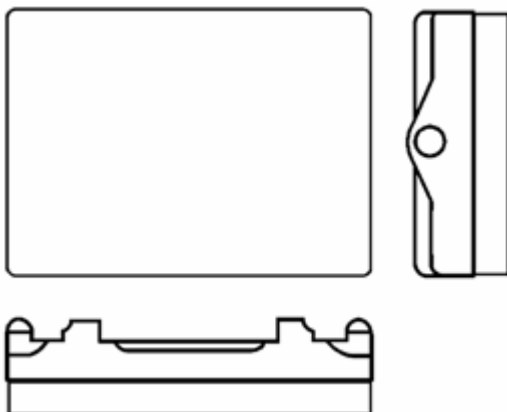

**PSP008**

89,7x73,8x15,0

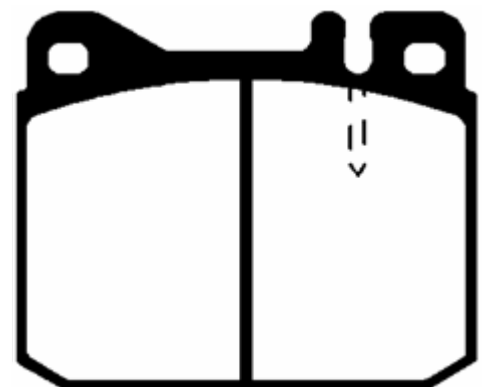

**PSP009**

90,0x76,0x17,0

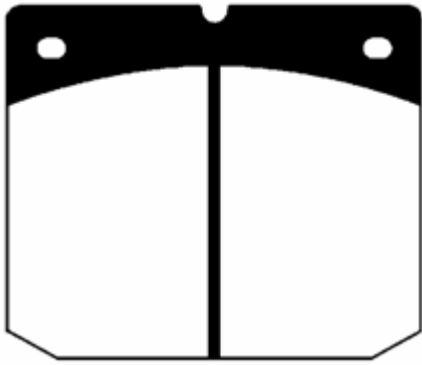

**PSP010**

90,0x102,0x23,0

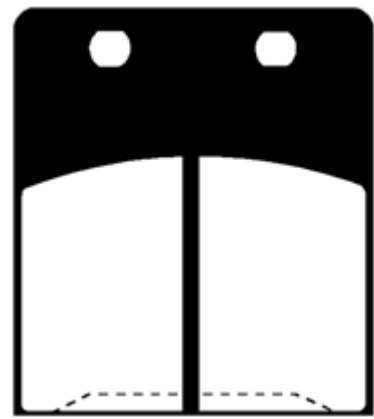

**PSP011**

91,0x66,0x16,0

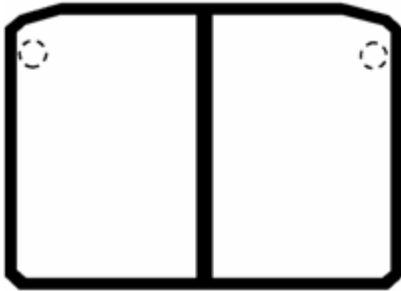

**PSP101**

105,0x77,0x22,5

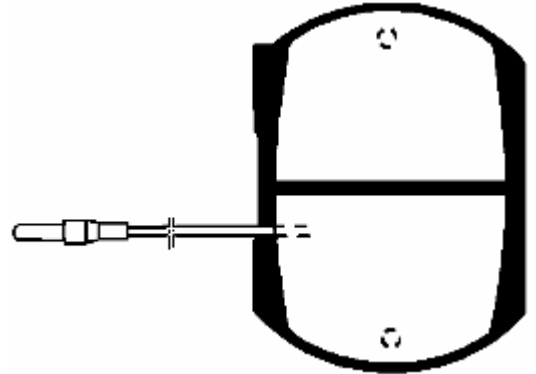

**PSP102**

106,0x77,0x22,0

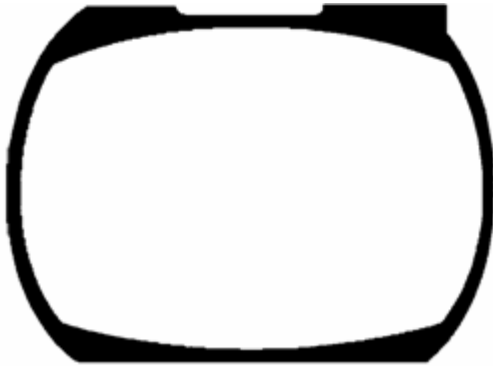

**PSP103**

108,0x45,0x16,0



**PSP104**

109,6x99,0x25,0

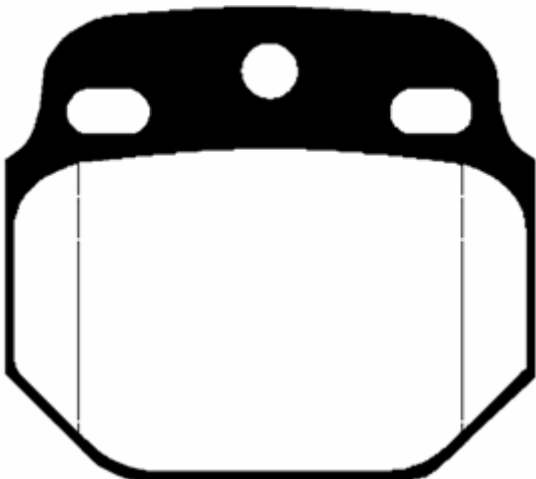

**PSP105**

110,0x38,0x11,0

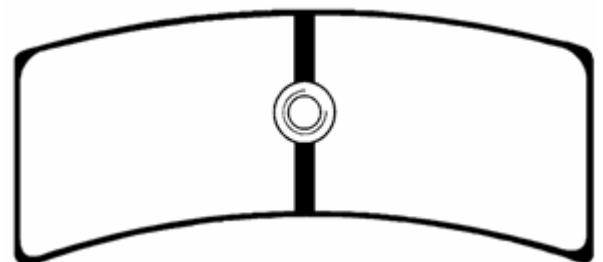

Les dessins ne sont à l'échelle 1

**PSP106**

110,0x48,0x

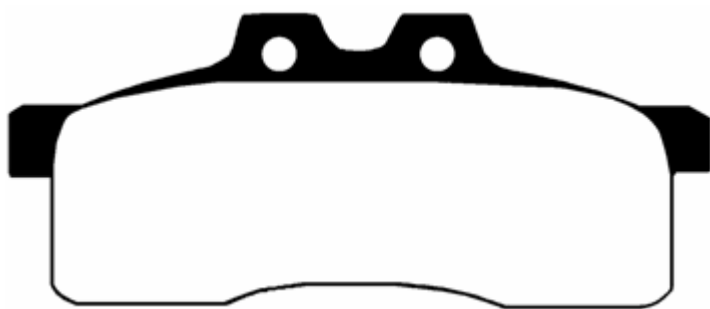

**PSP107**

114,5x101,0x12,5

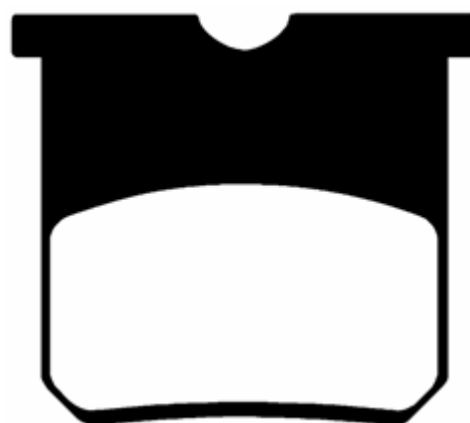

**PSP108**

115,0x66,0x16,0

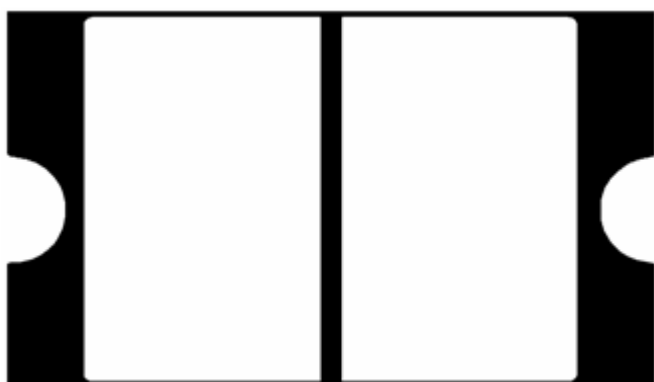

**PSP109**

117,0x83,0x19,0

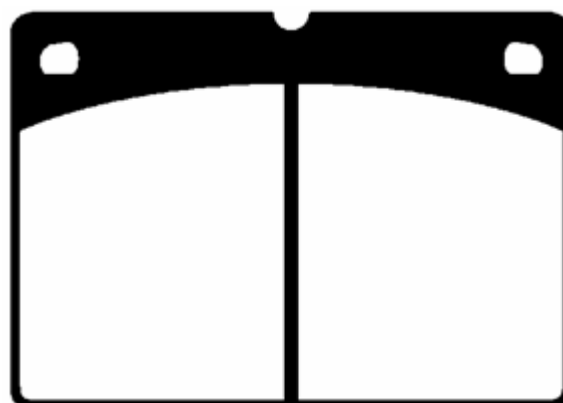

**PSP110**

117,5x107,0x21,5

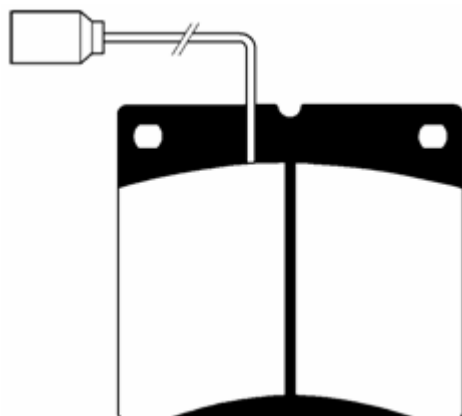

**PSP111**

117,5x107,0x21,5

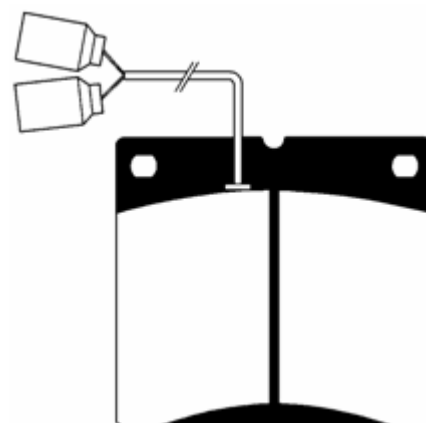

**PSP112**

117,5x107,0x21,5

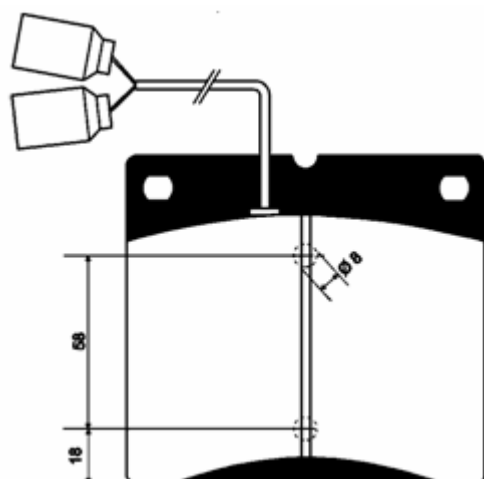

**PSP113**

117,5x117,5x22,0

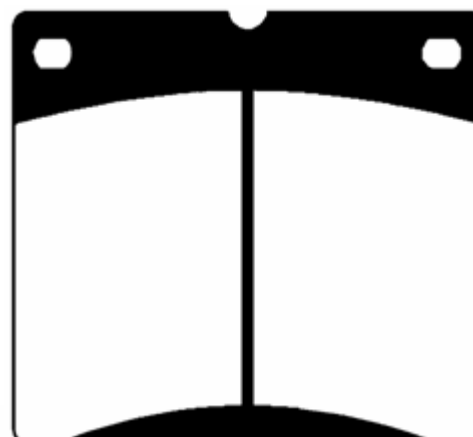

**PSP114**

132,2x103,8x24,0

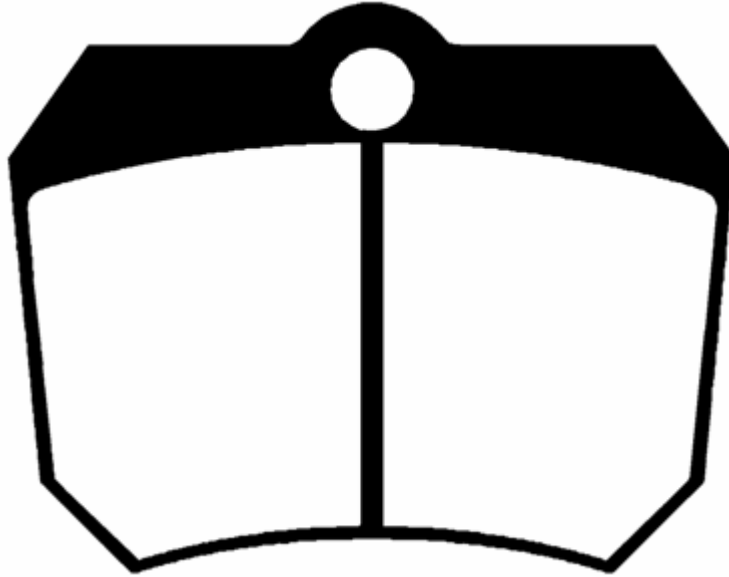

**PSP115**

136,0x103,8x24,0

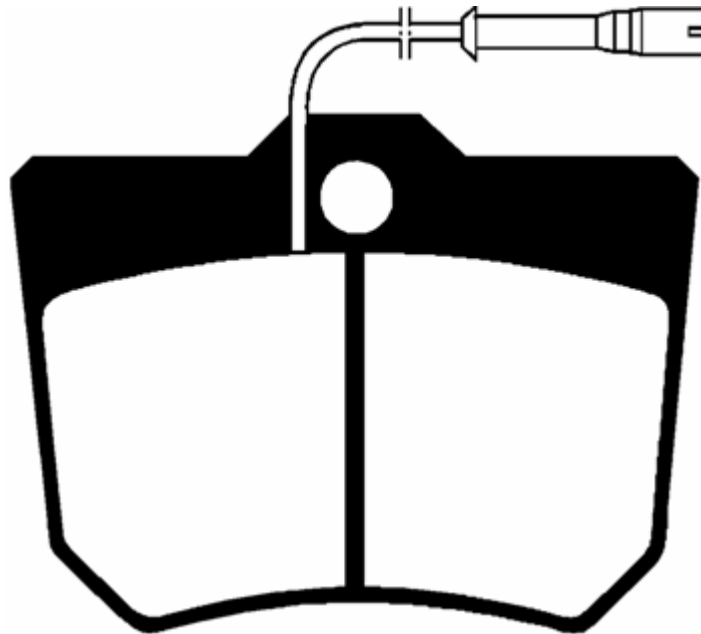

**PSP116**

136,4x103,8x23,8



**PSP117**

137,2x115,0x25,0

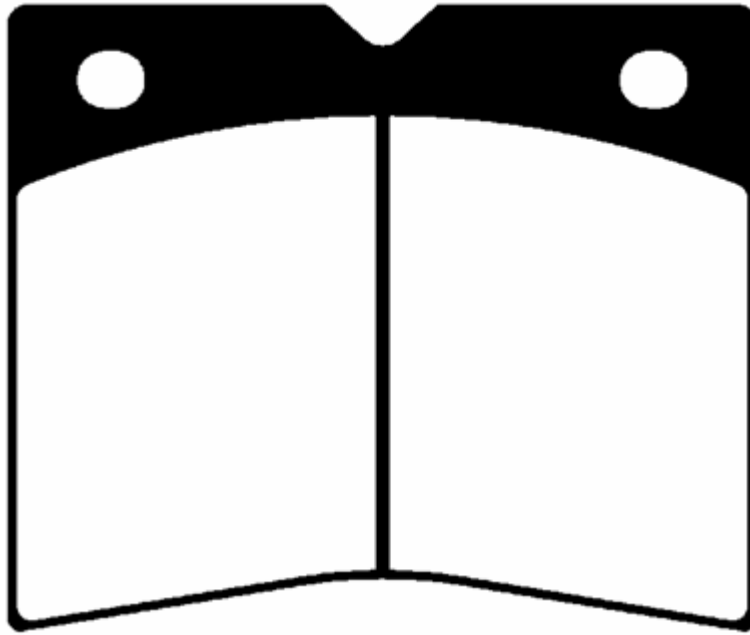

**PSP118**

137,7x82,0x11,0

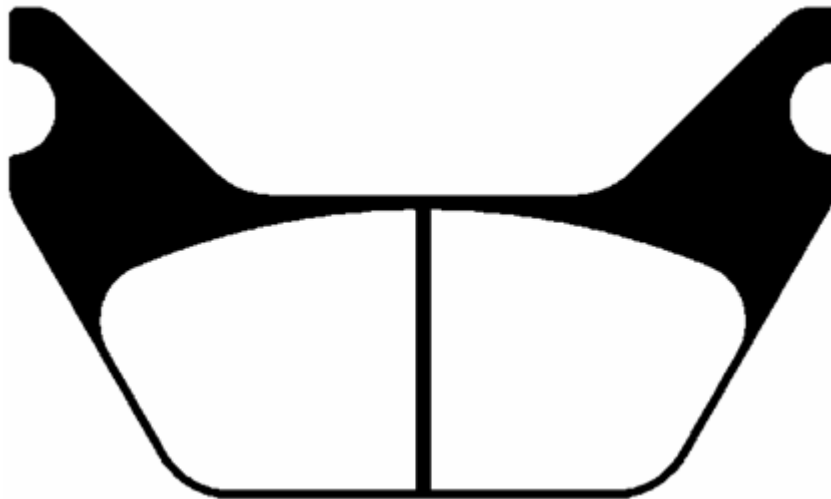

**PSP119**

137,7x82,0x14,0

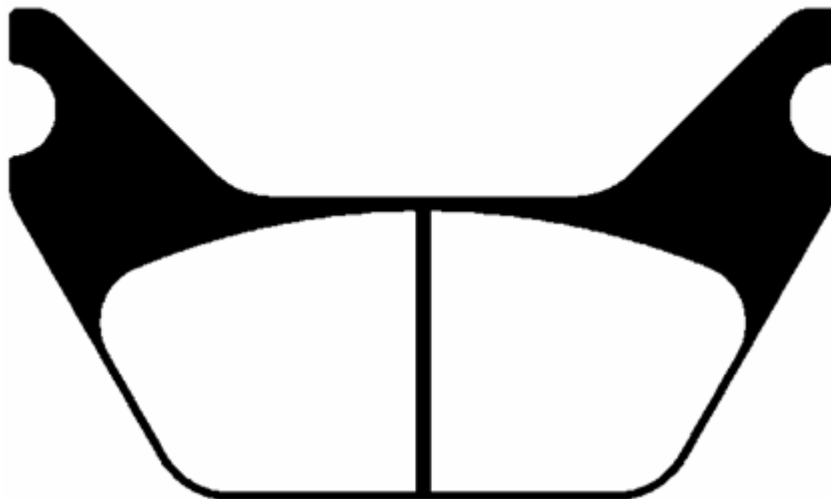



**PSP120**

139,0x121,0x32,0

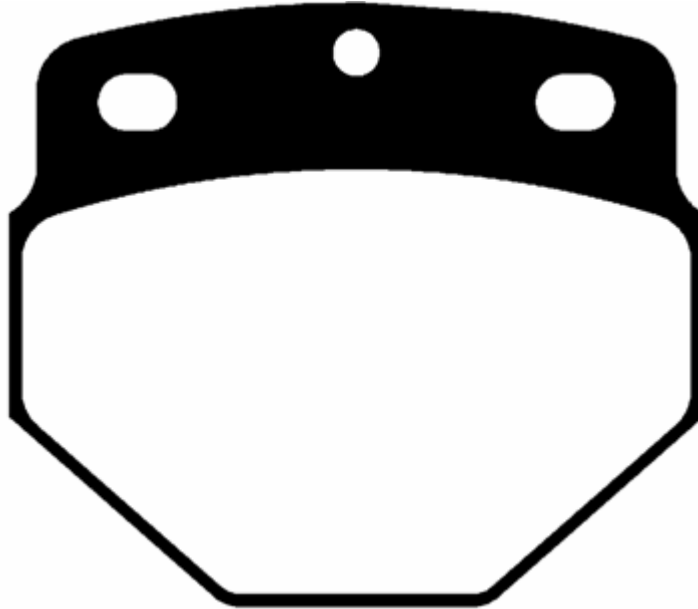

**PSP121**

147,0x116,0x26,0

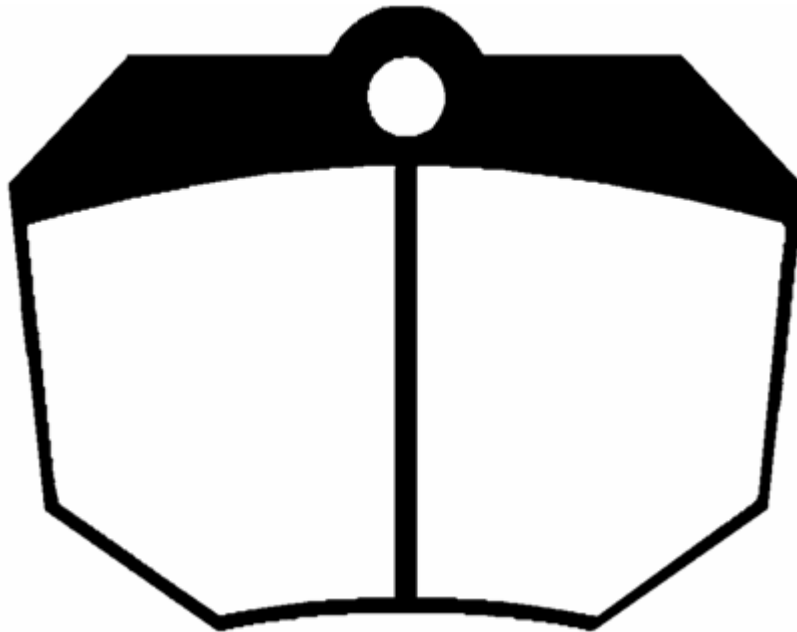

**PSP122**

149,6x81,5x20,3

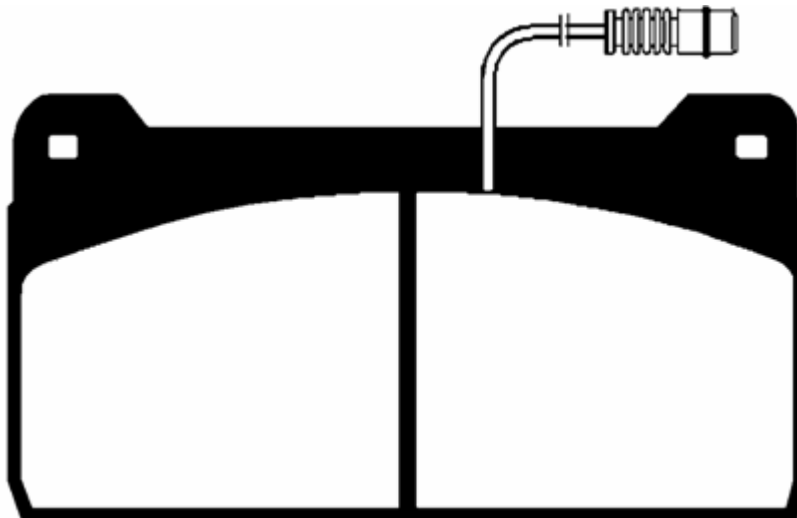

**PSP123**

151,2x114,4x26,0

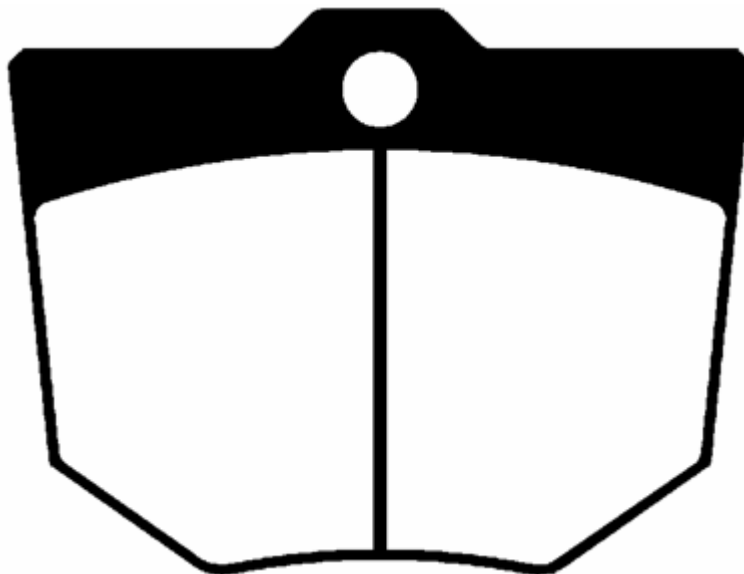

**PSP124**

151,2x114,4x26,0

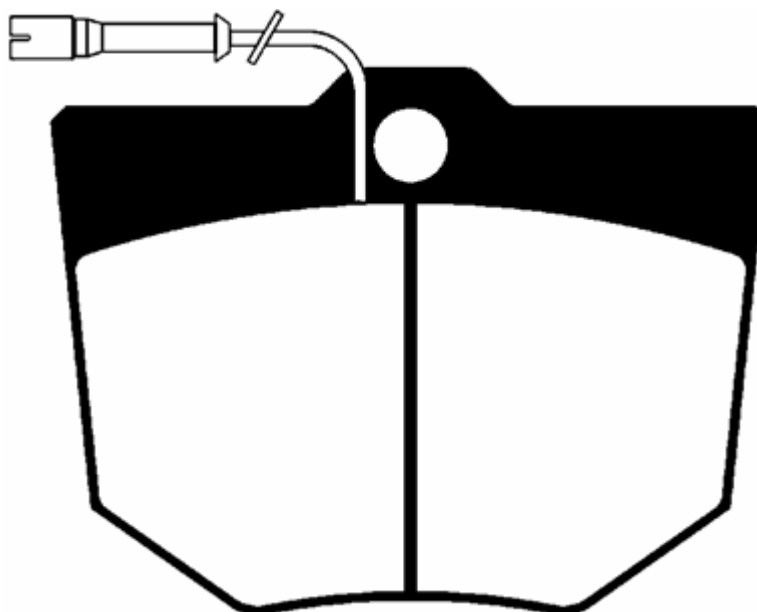

**PSP125**

153,9x96,5x25,0

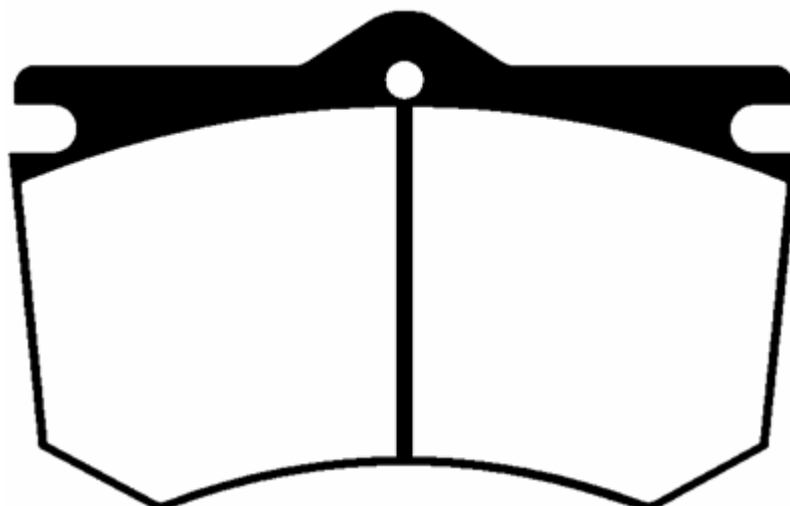

**PSP126**

154,0x90,0x20,0

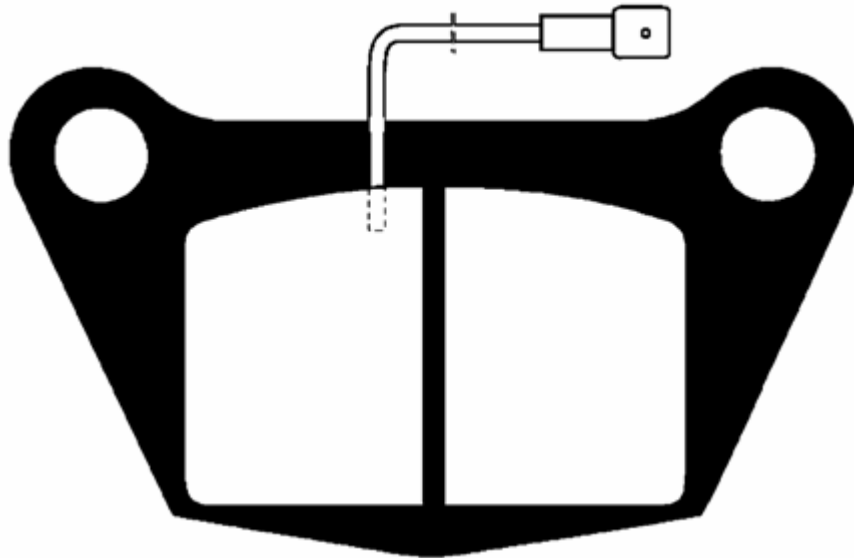

**PSP127**

159,0x110,0x14,0

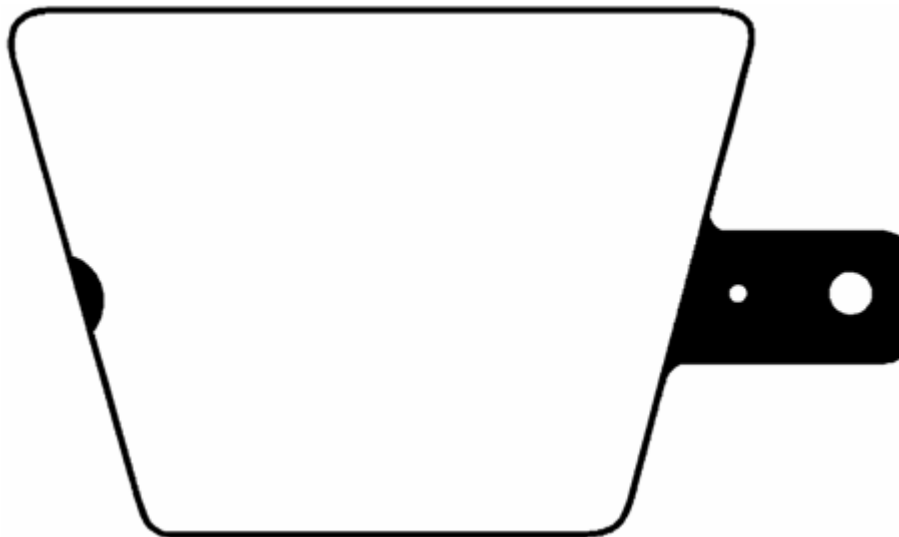

**PSP128**

162,2x111,3x27,5

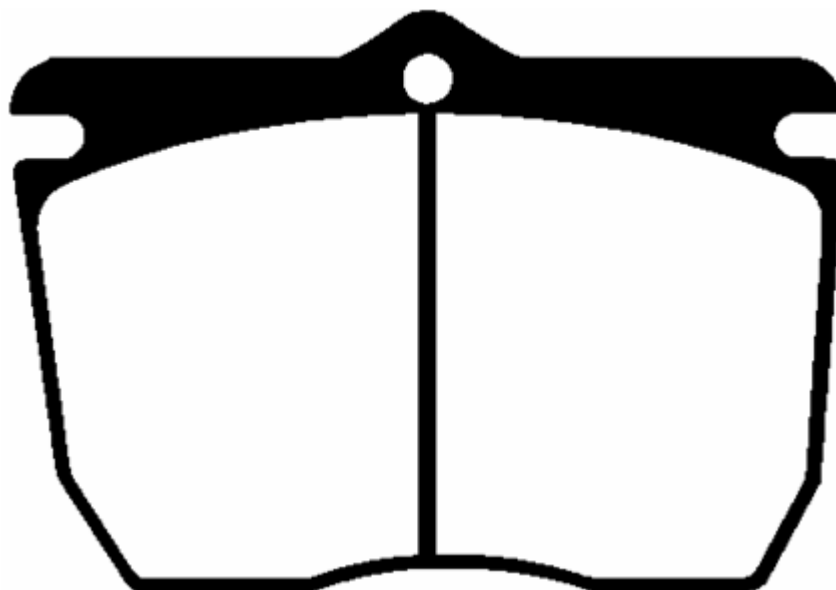

**PSP129**

162,2x111,3x27,5

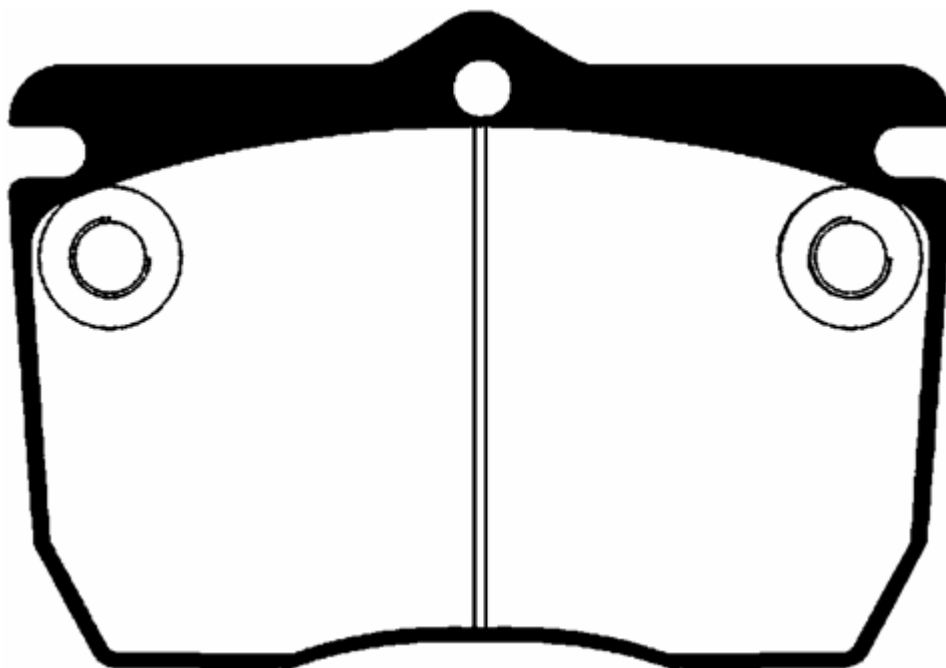

**PSP130**

162,2x111,3x27,5

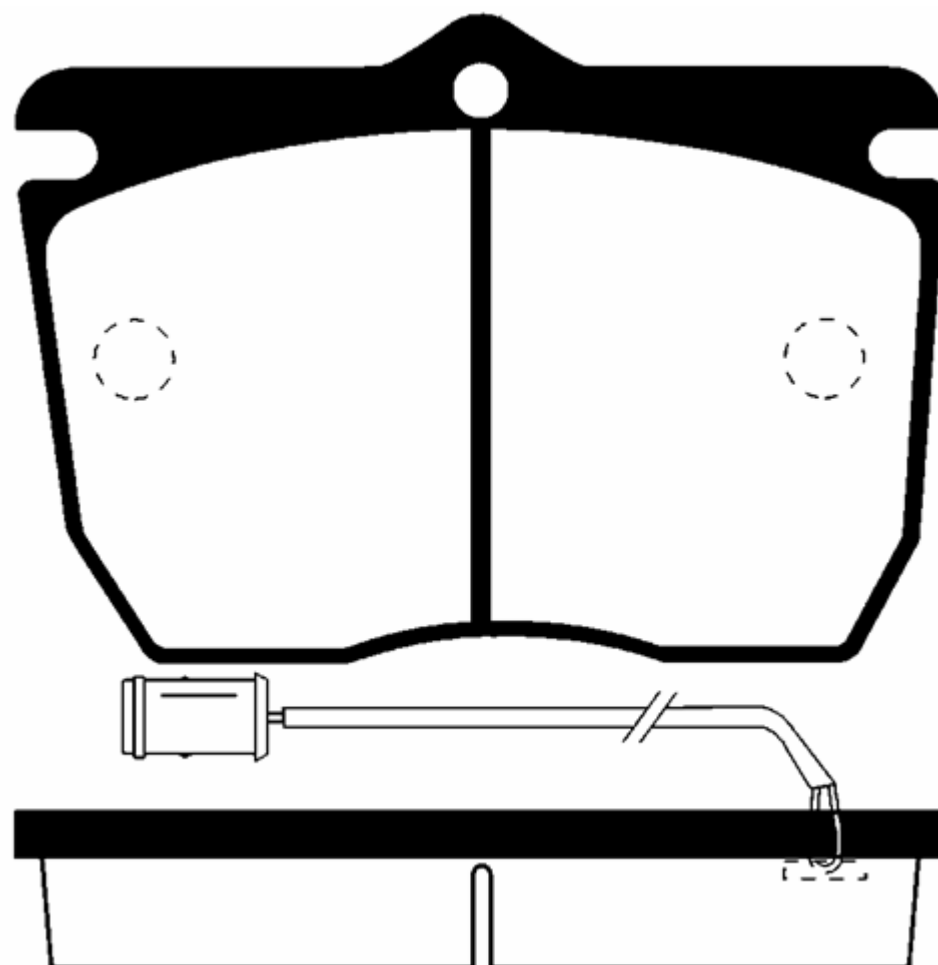

**PSP131**

177,0x74,0x22,5

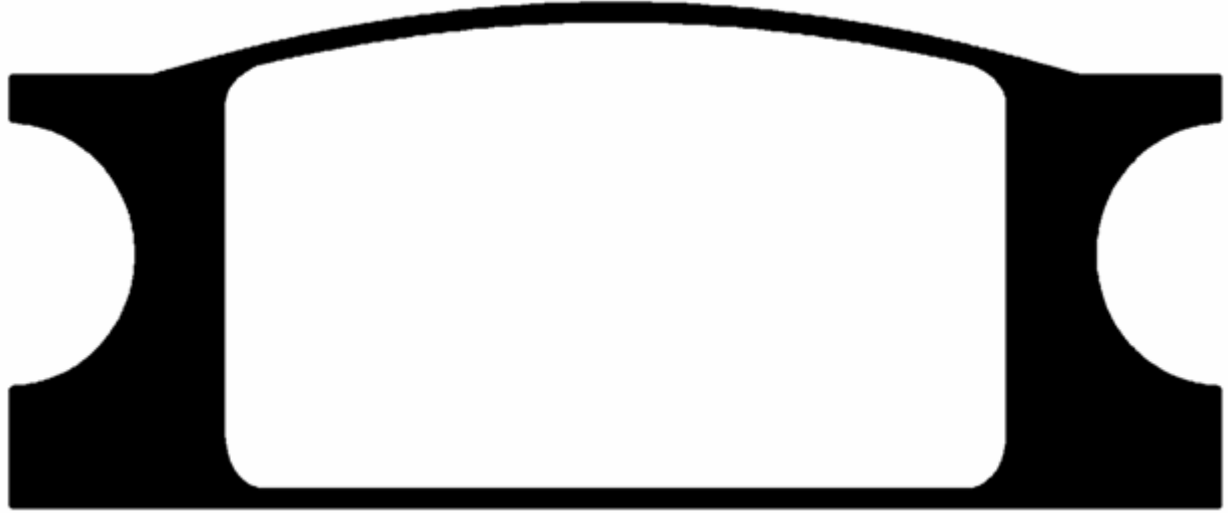

**PSP132**

180,0x113,0x20,0

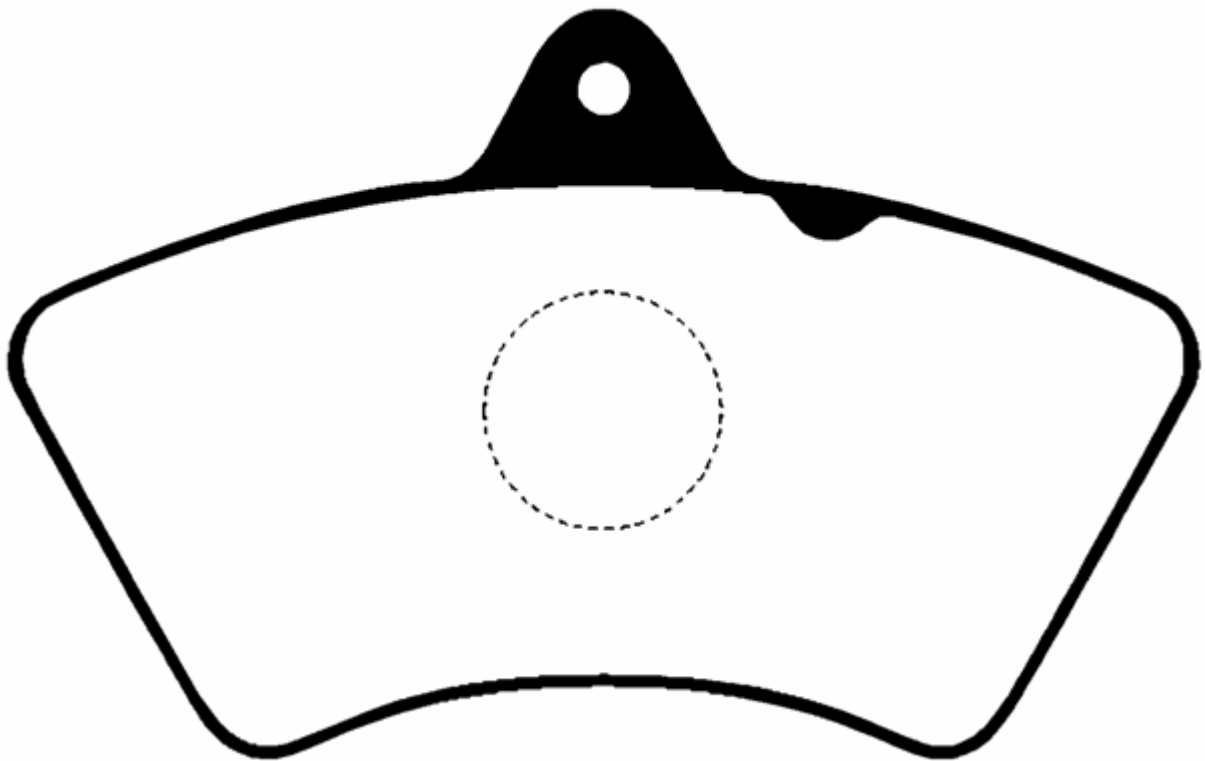

**PSP201**

200,0x127,0x20,0

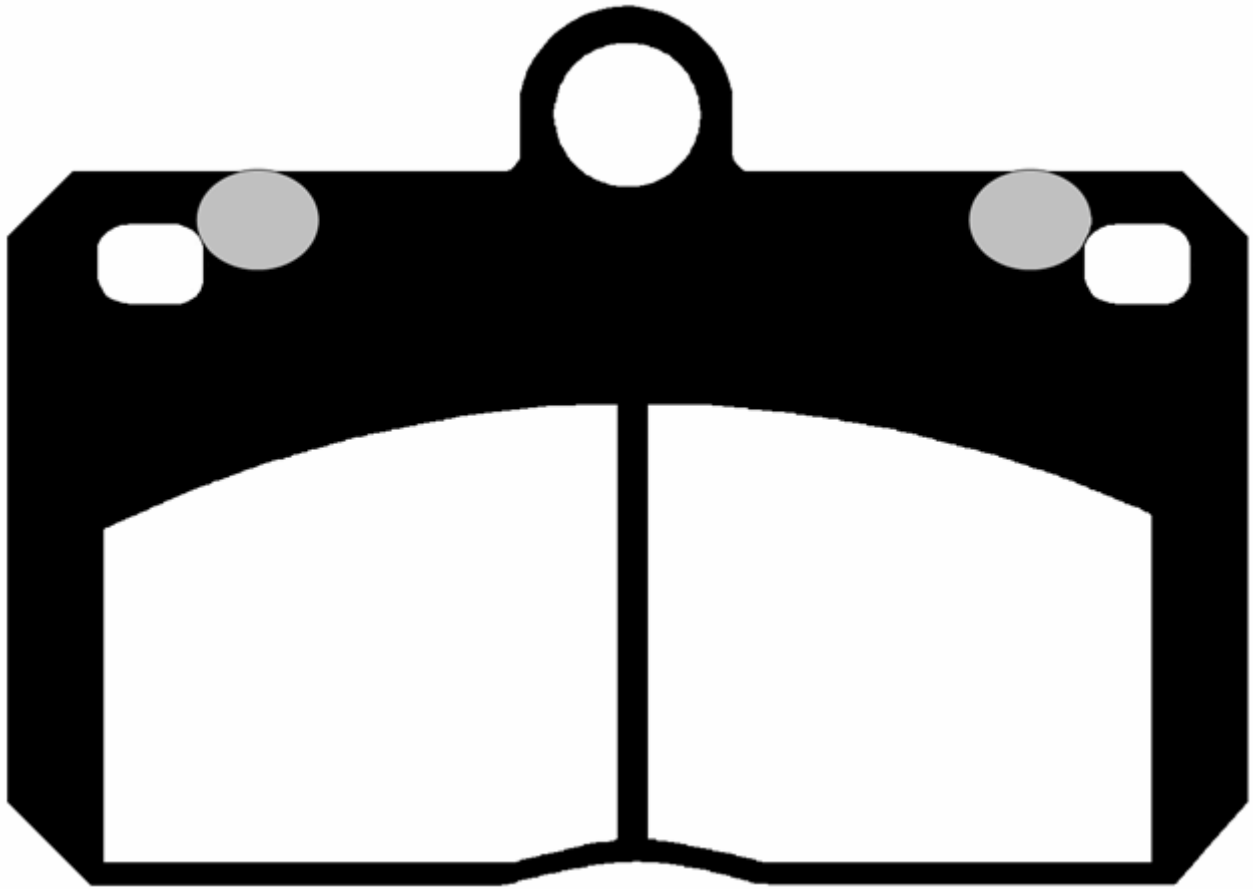

**PSP202**

201,0x67,5x28,0

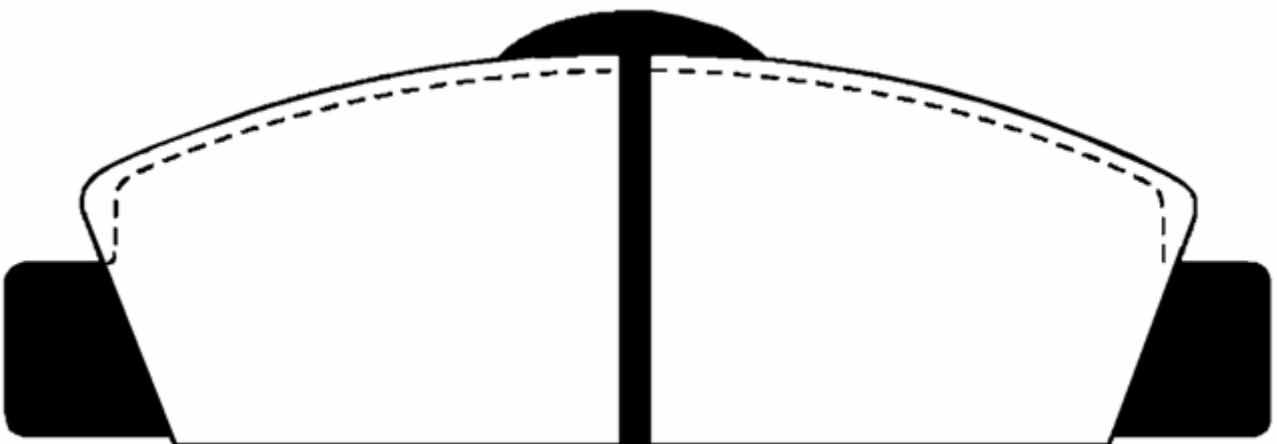

**PSP203**

208,6x91,5x17,7

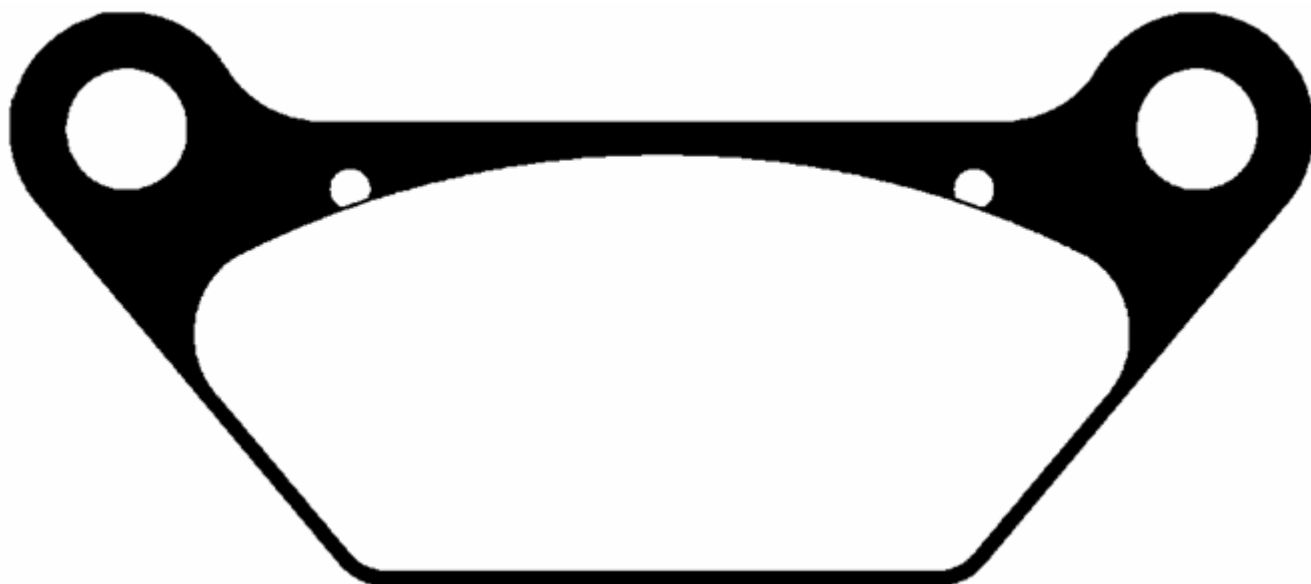

**PSP204**

220,0x79,0x22,0

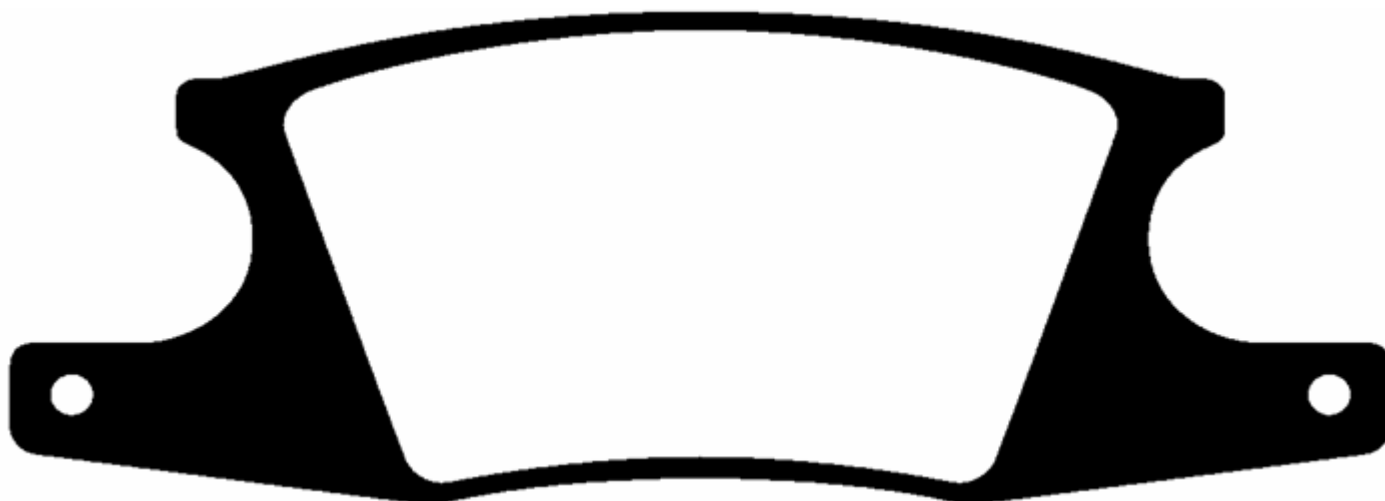

**PSP205**

226,0x90,0x18,0

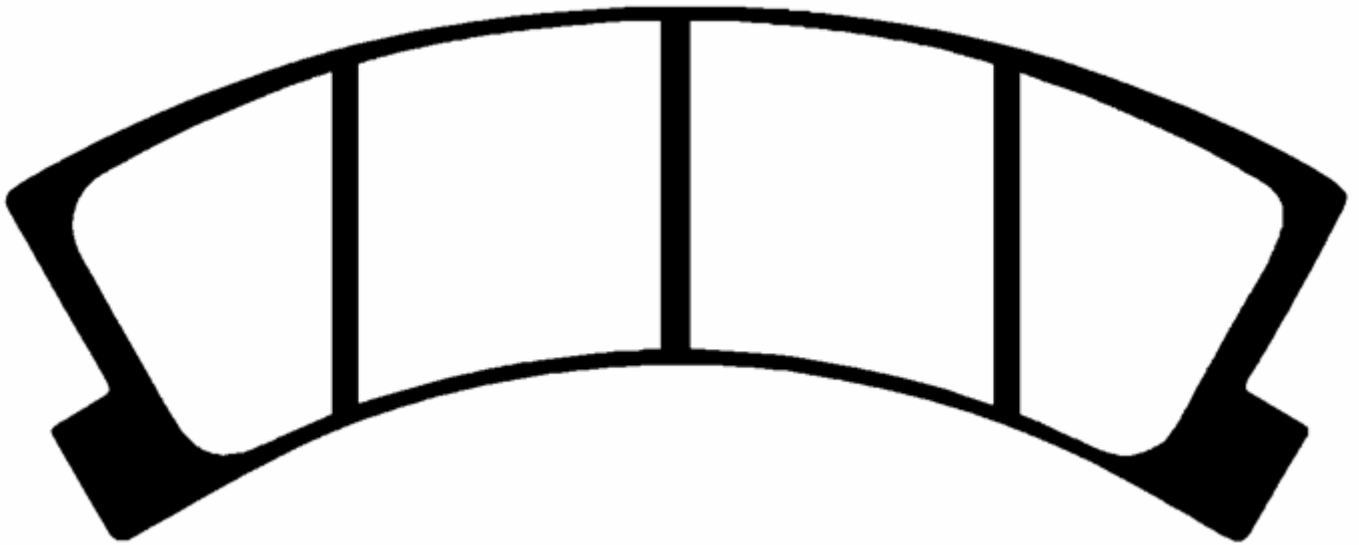

**PSP206**

258,3x112,5x18,0

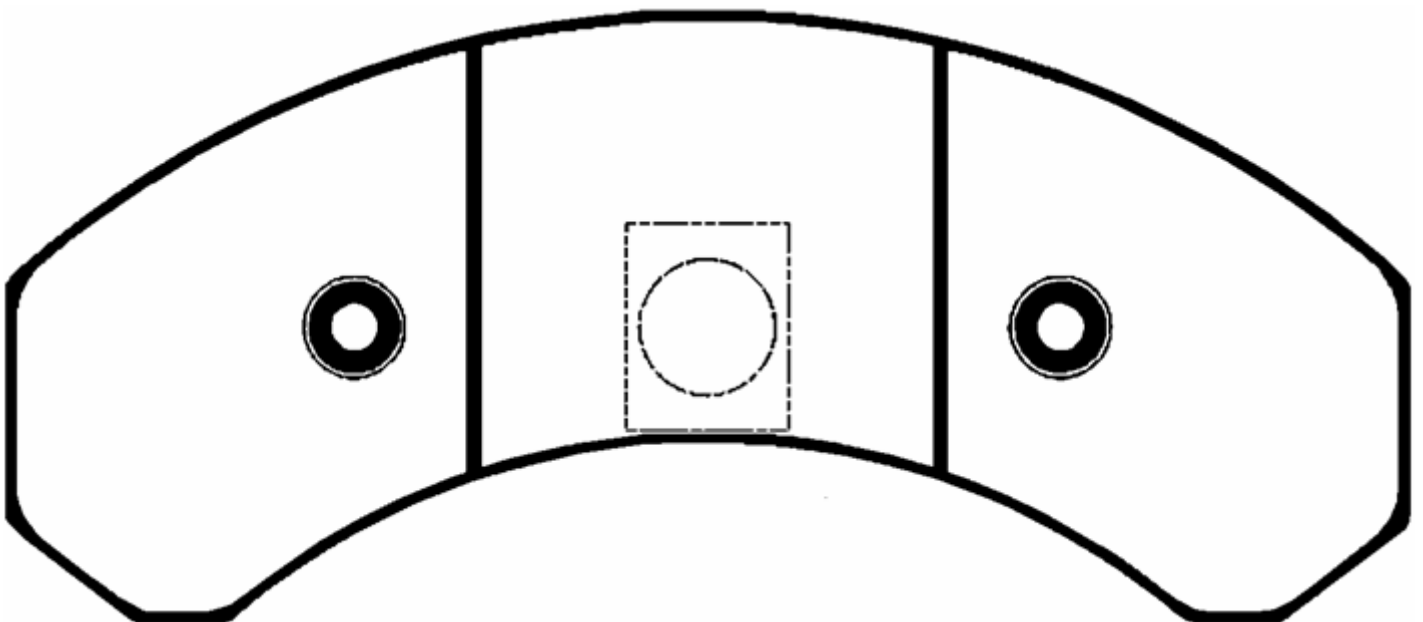



**PSP207**

260,0x88,0x32,0

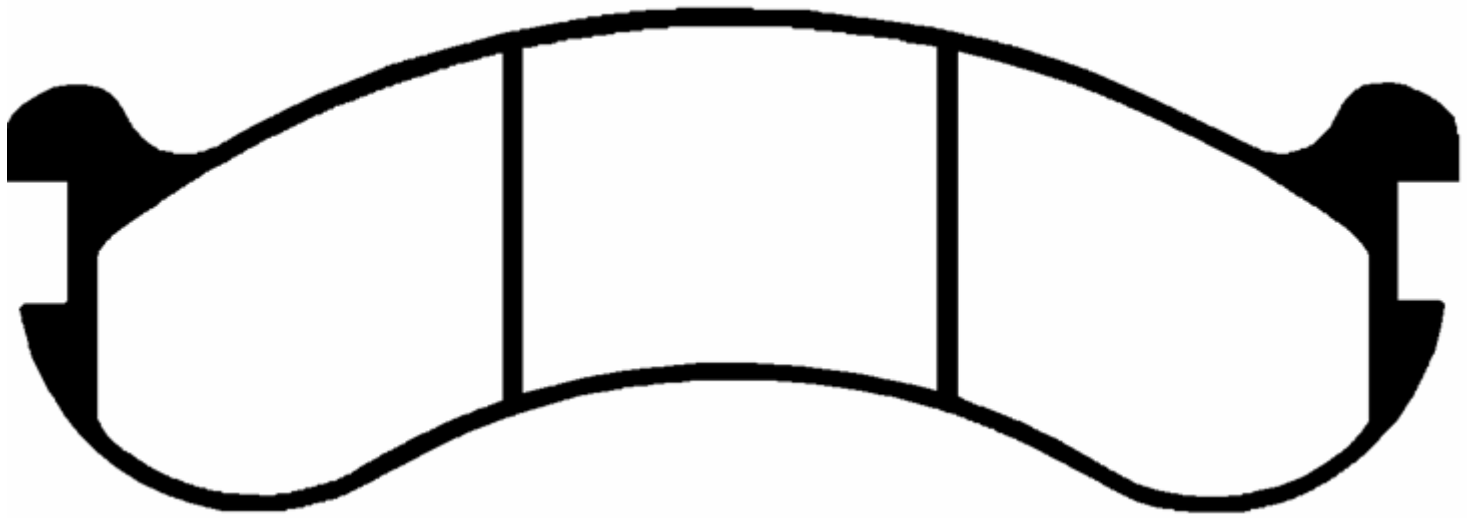

**PSP208**

277,0x86,0x

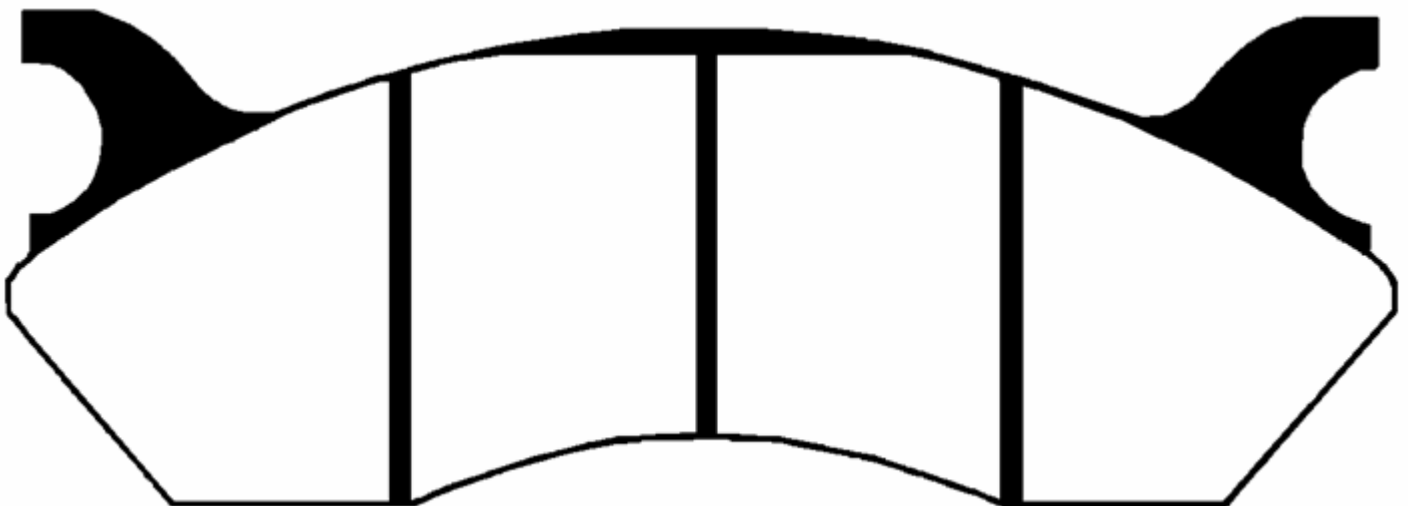

**PSP209**

277,8x85,7x22,2

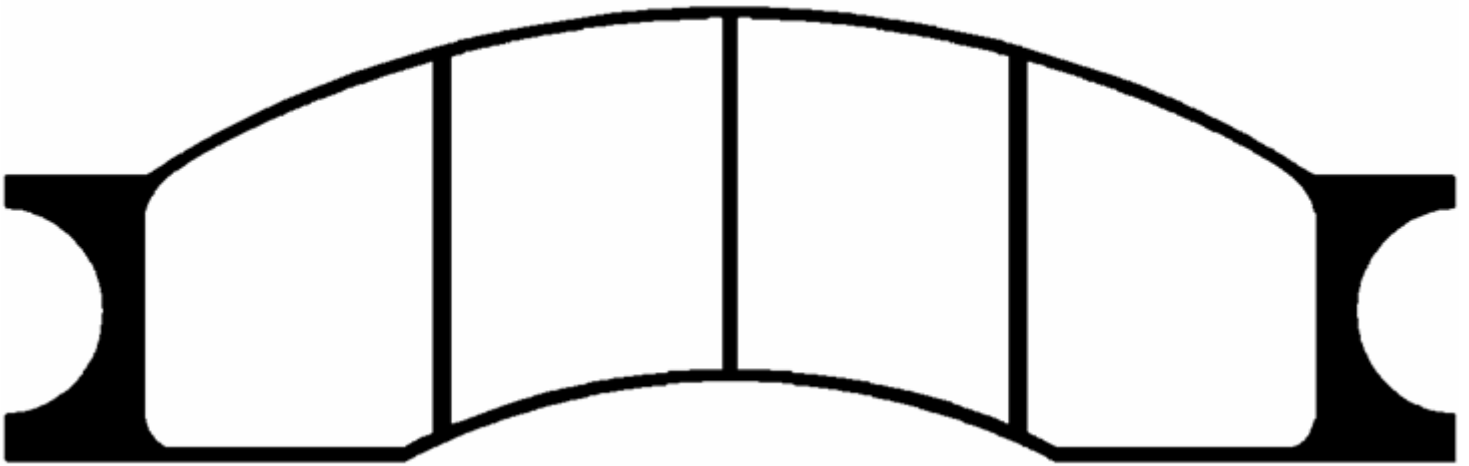

**PSP210**

277,8x104,0x24,0

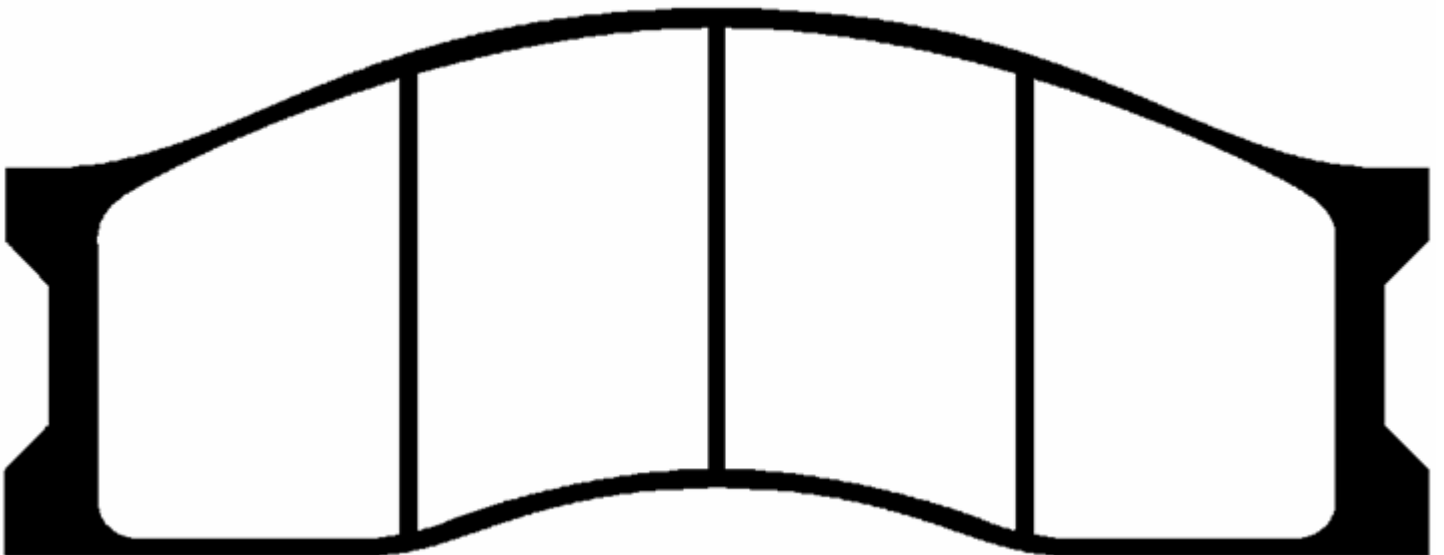

**PSP301**

304,0x124,0x15,0

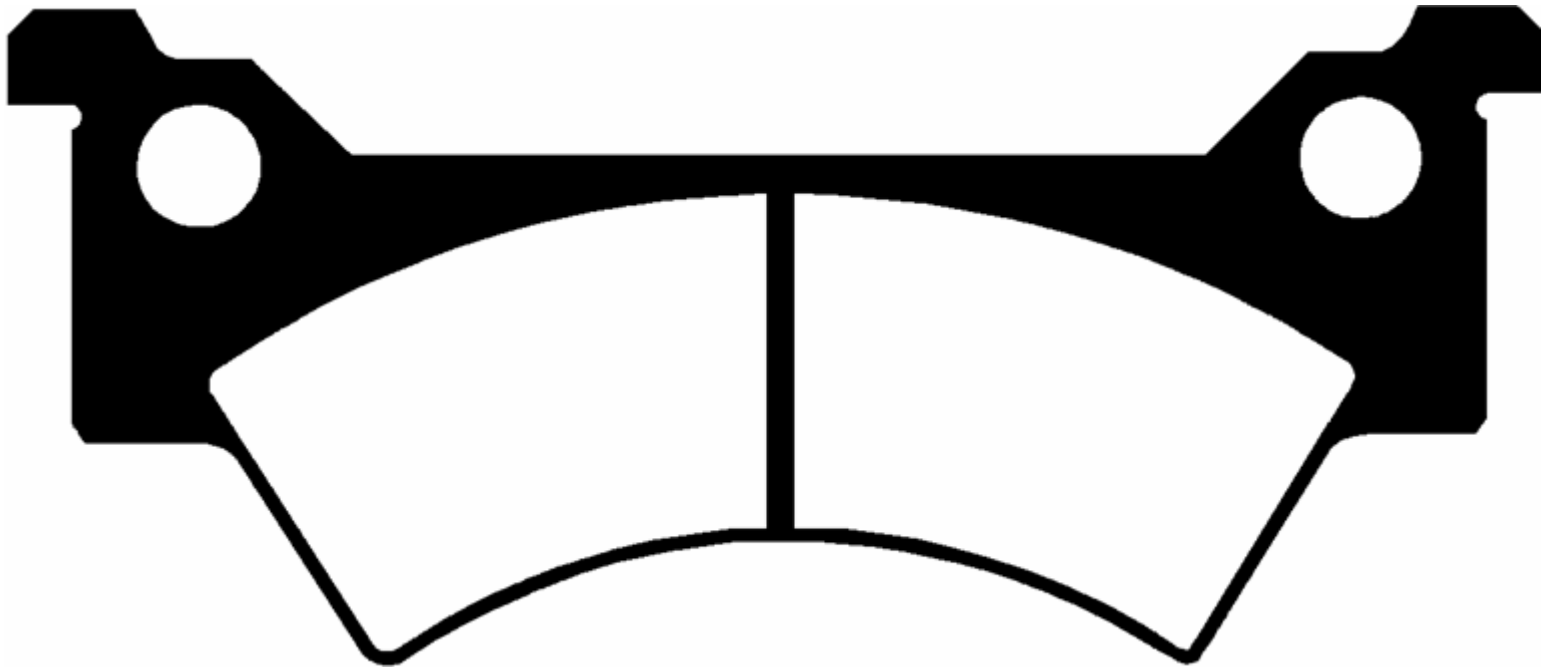

**PSP302**

315,0x110,0x14,0

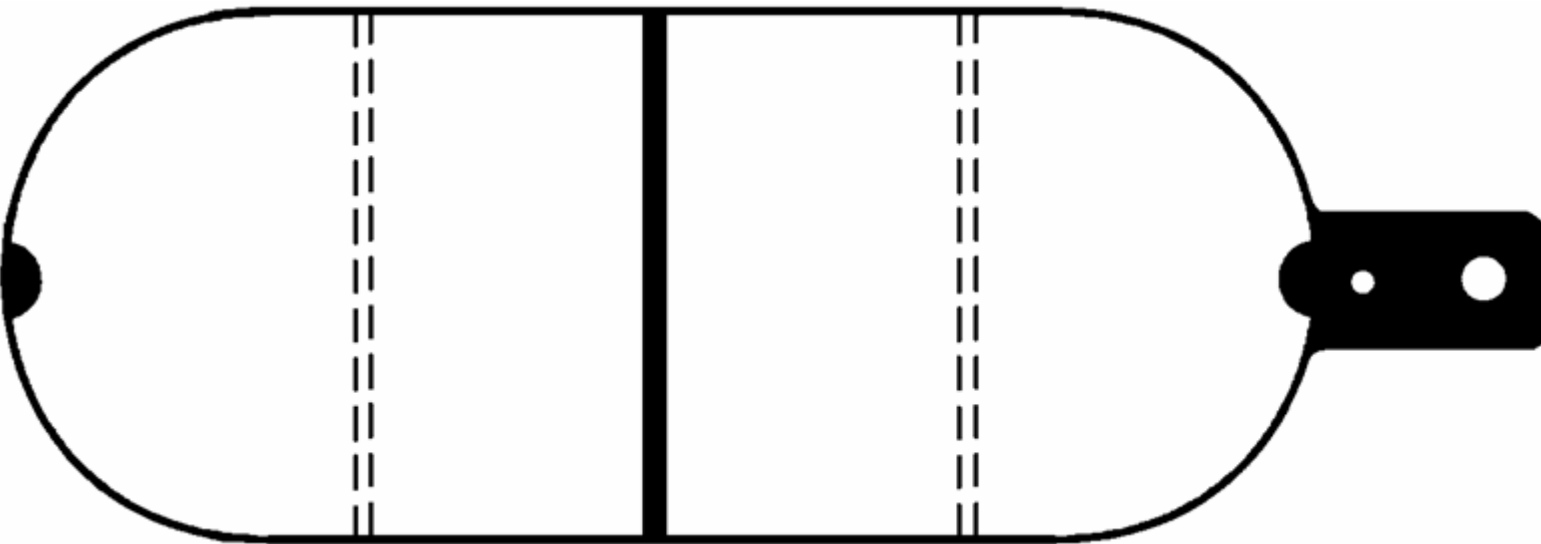

**PSP303**

320,0x97,9x22,0

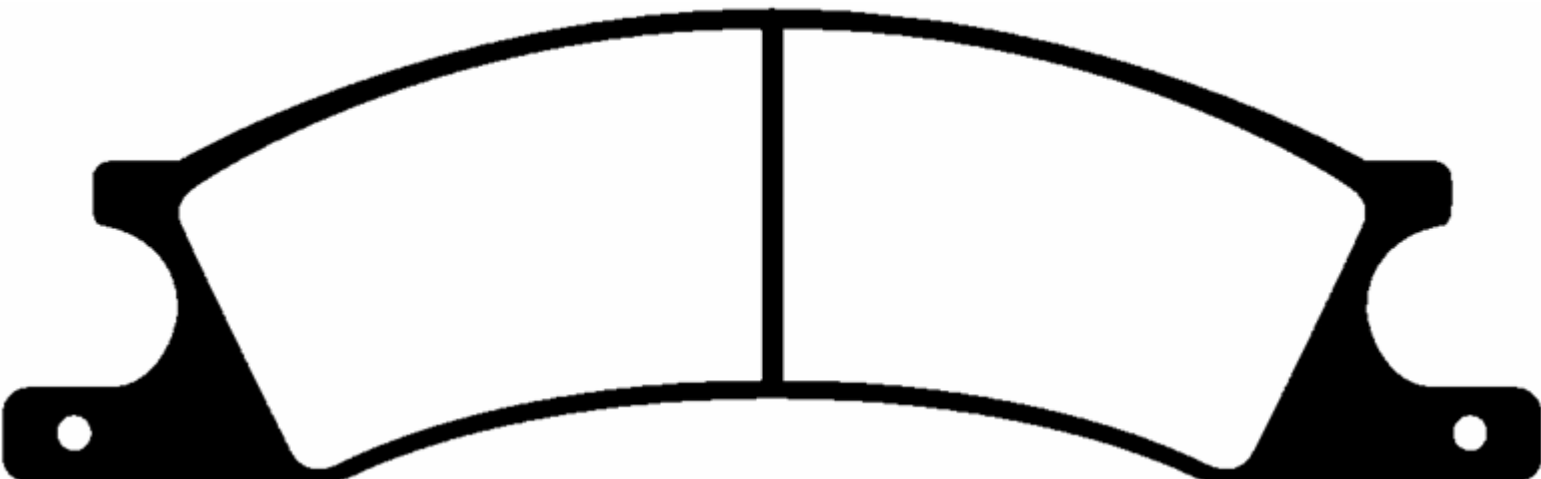

**PSP304**

321,0x108,3x25,0

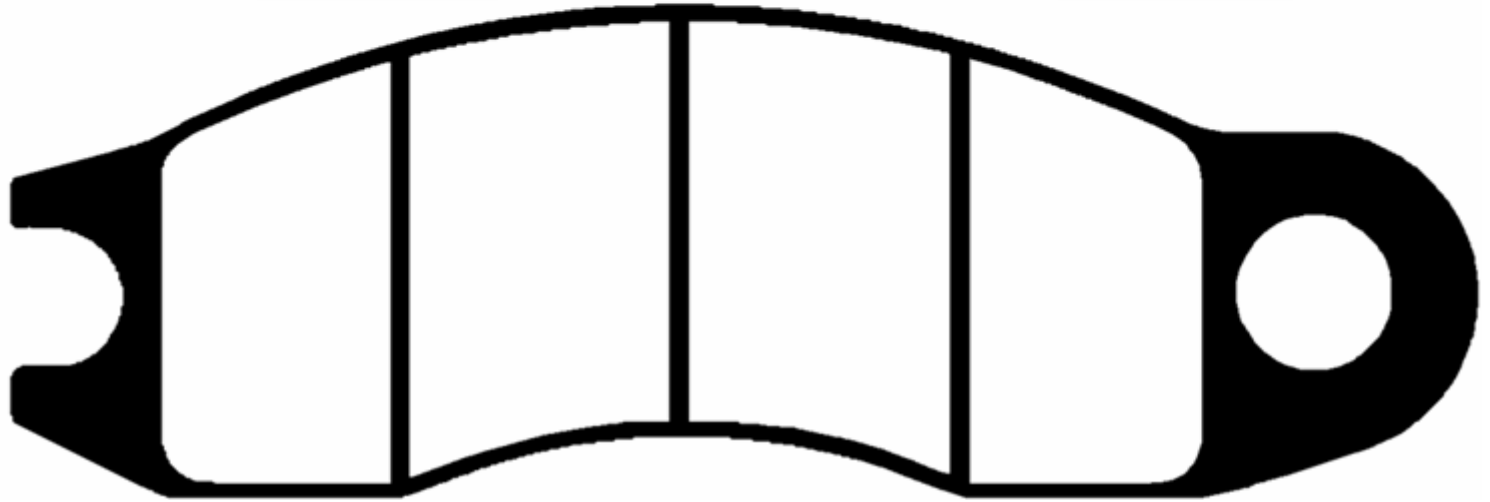
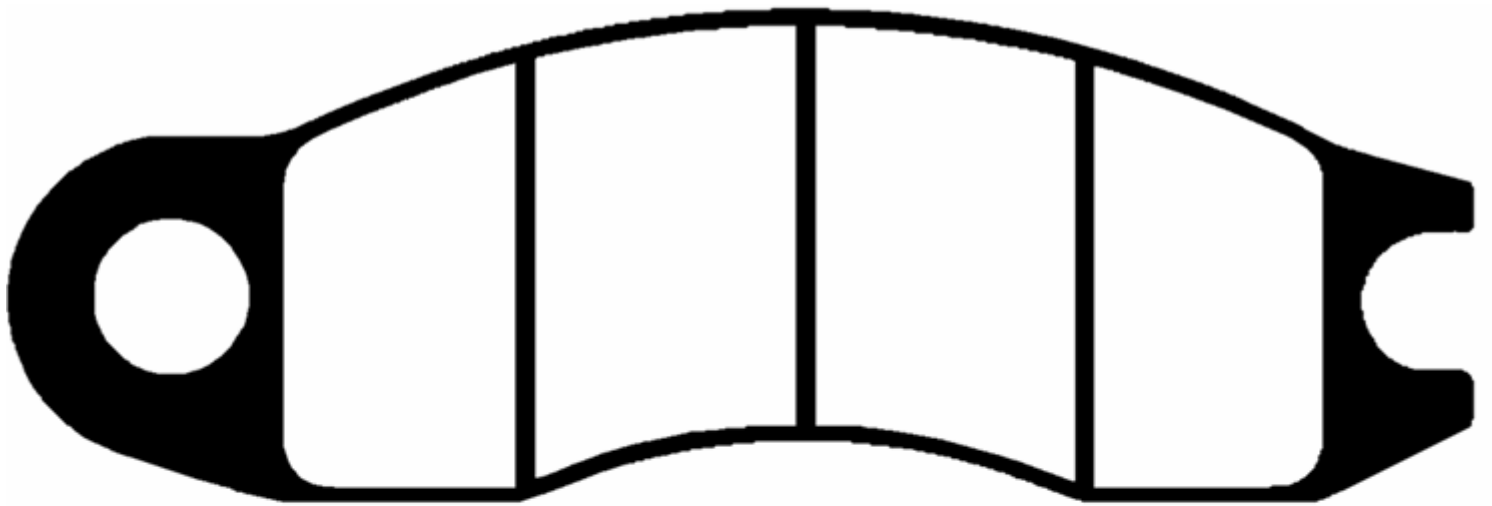

**PSP305**

321,0x155,0x36,0

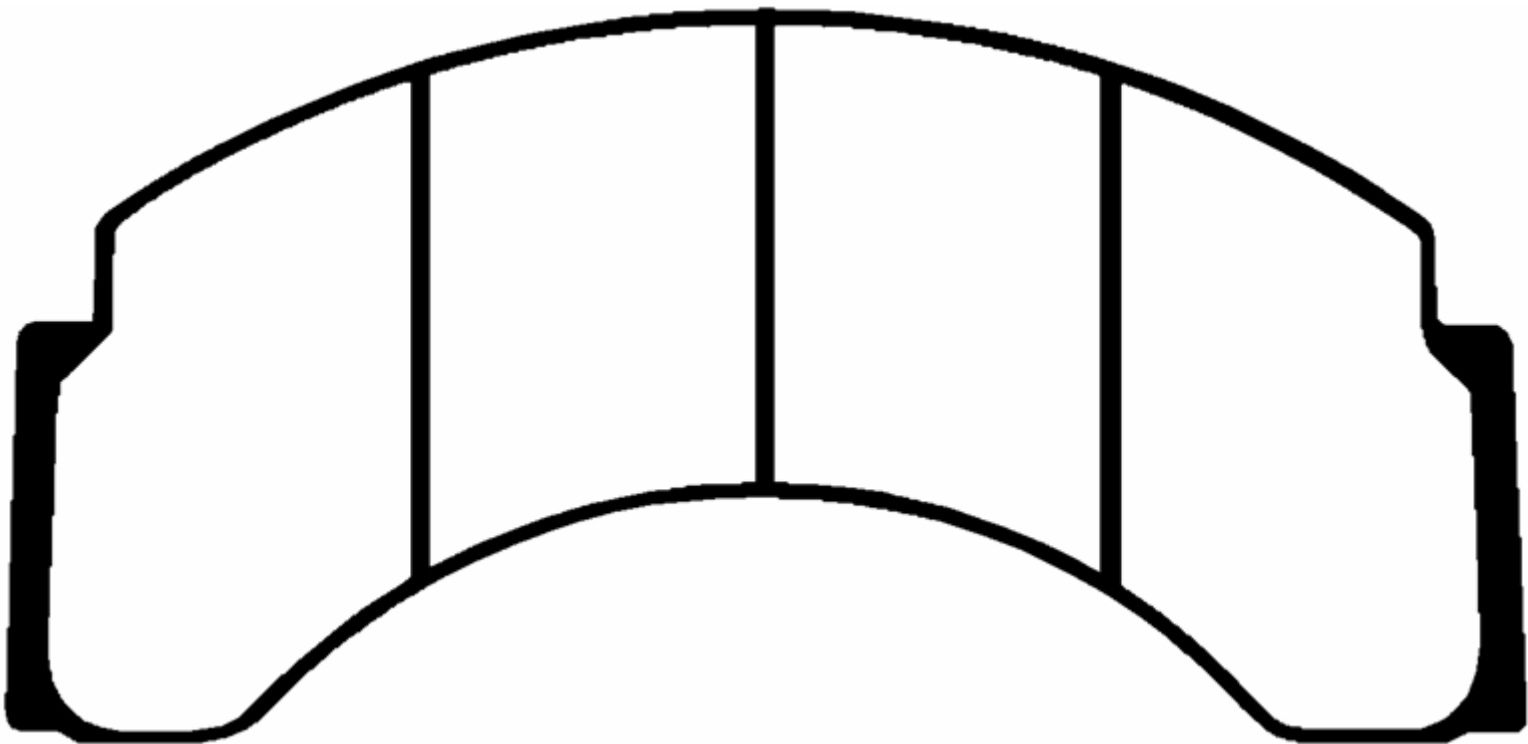

**PSP306**

326,0x102,0x28,0

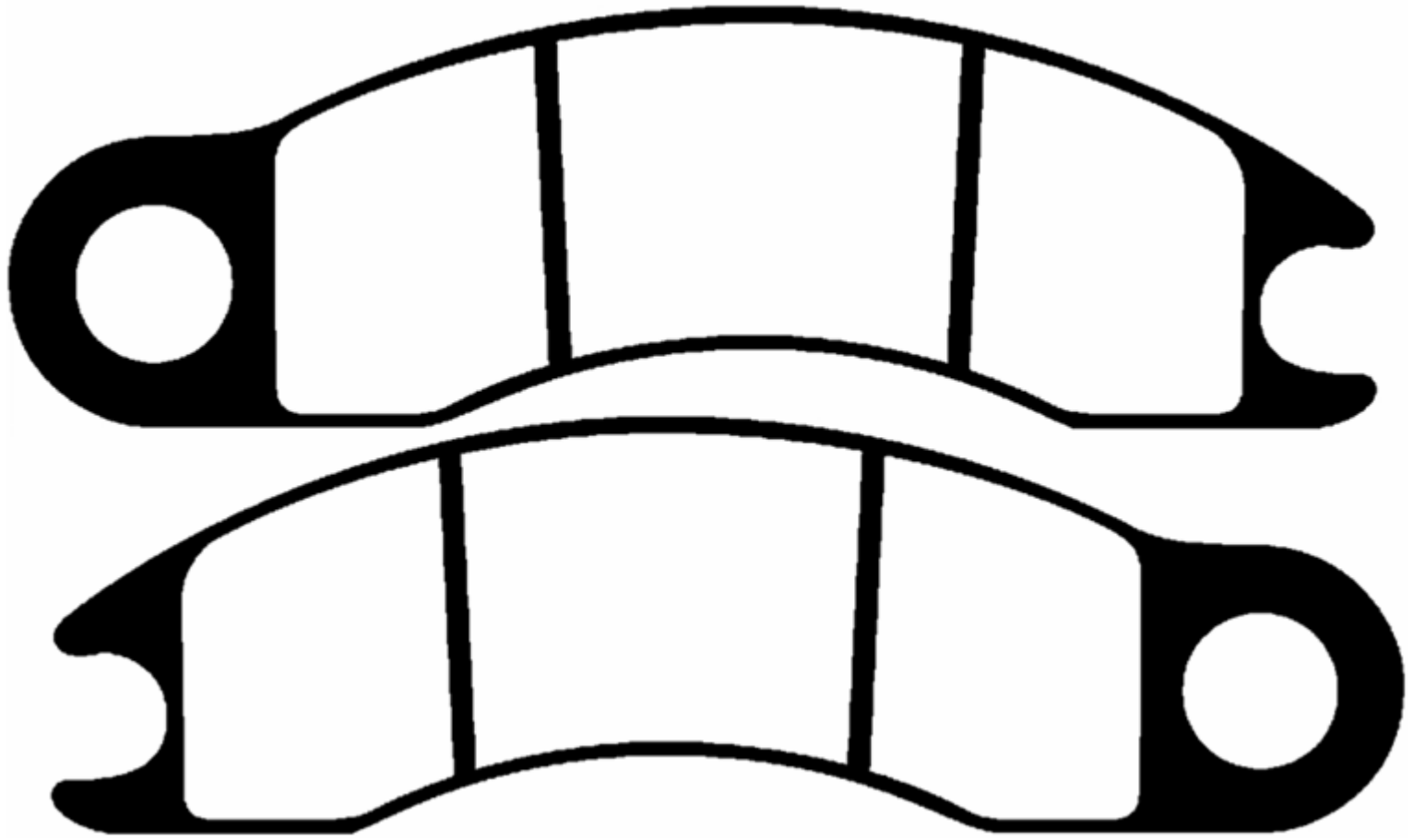

**PSP307**

334,0x81,0x25,0

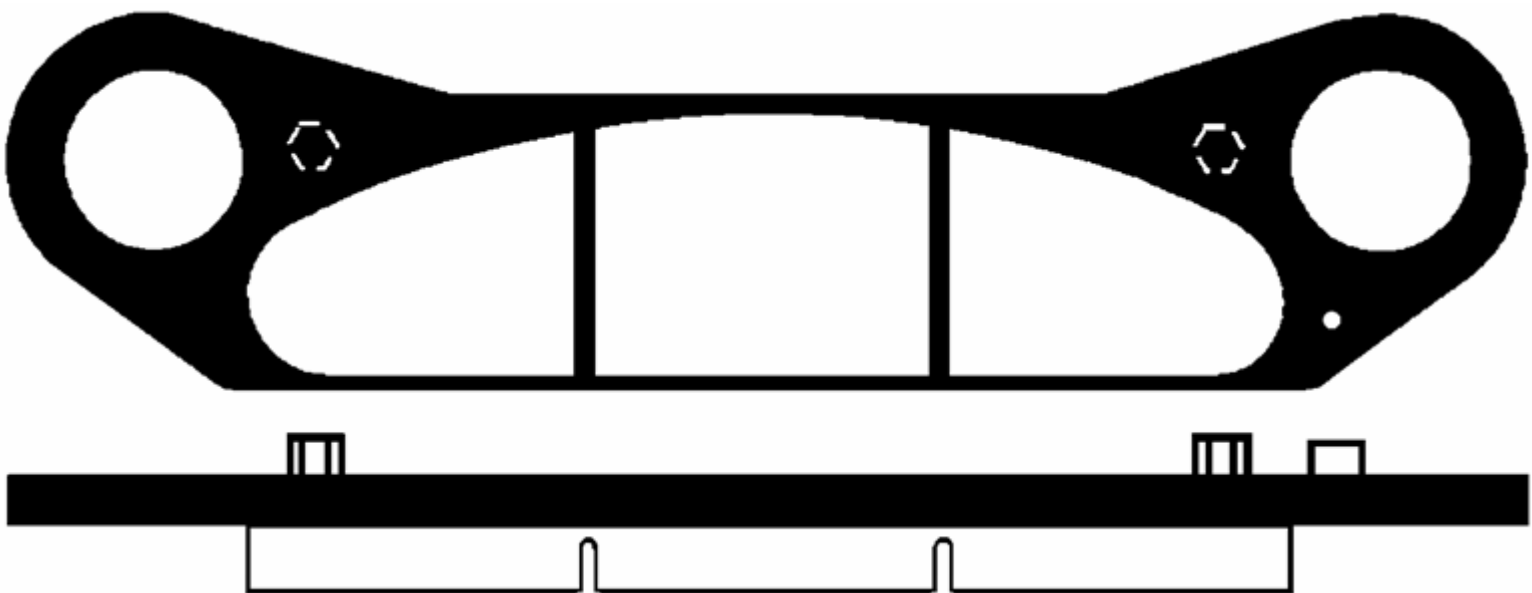

**PSP308**

370,0x108,0x

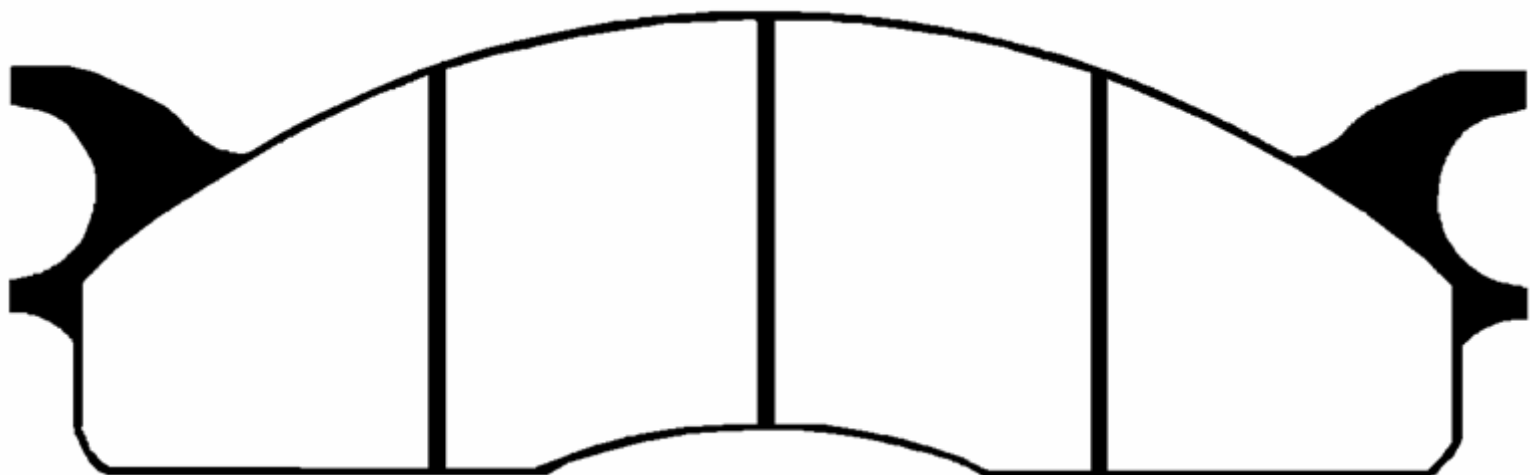

**PSP309**

370,8x130,0x27,5

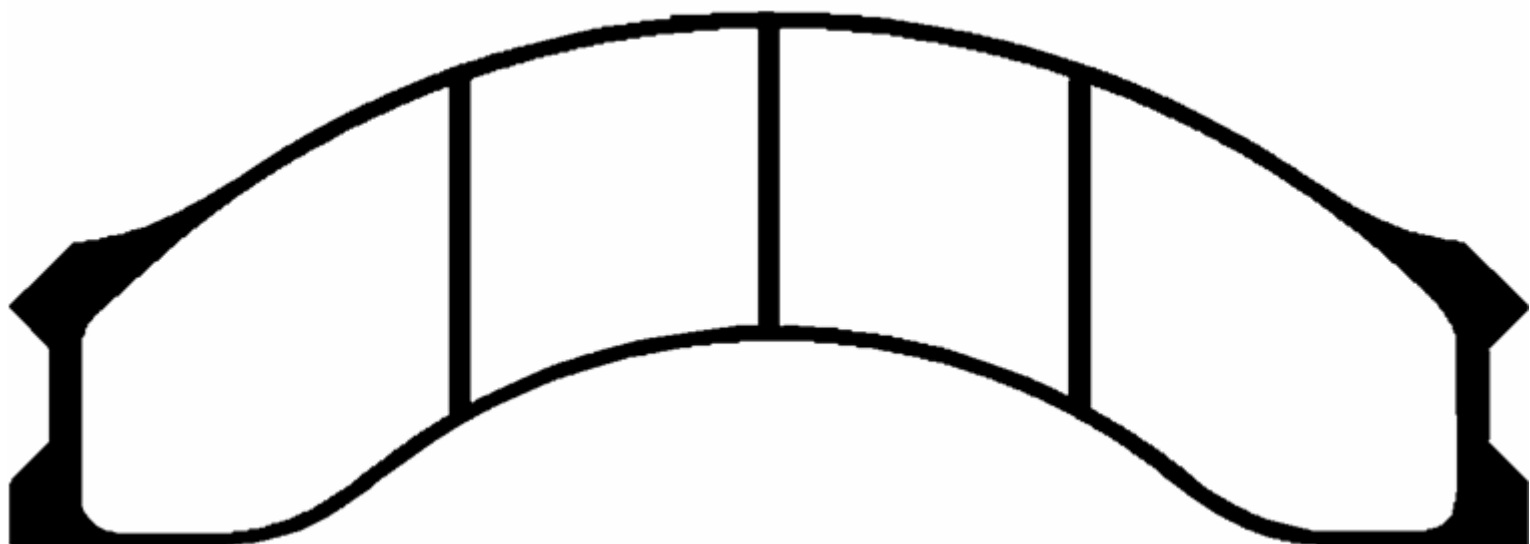

**PSP310**

385,0x140,5x29,0

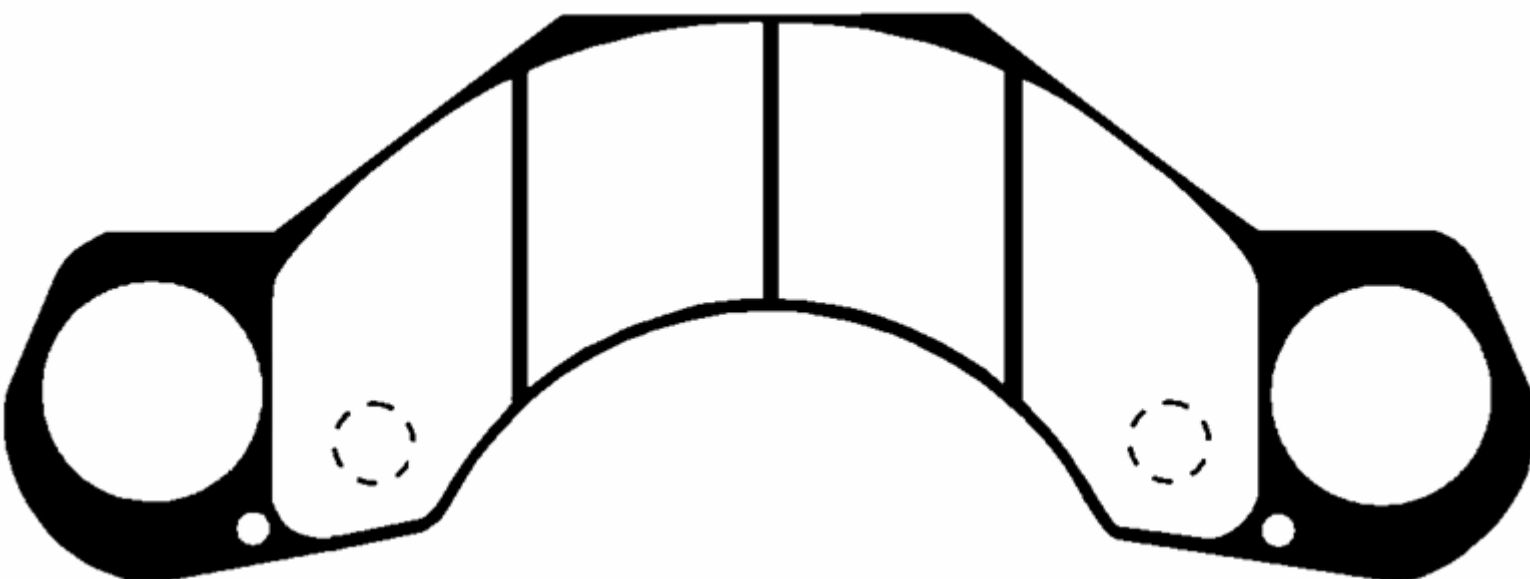

PSP311

397,0x125,0x28,0

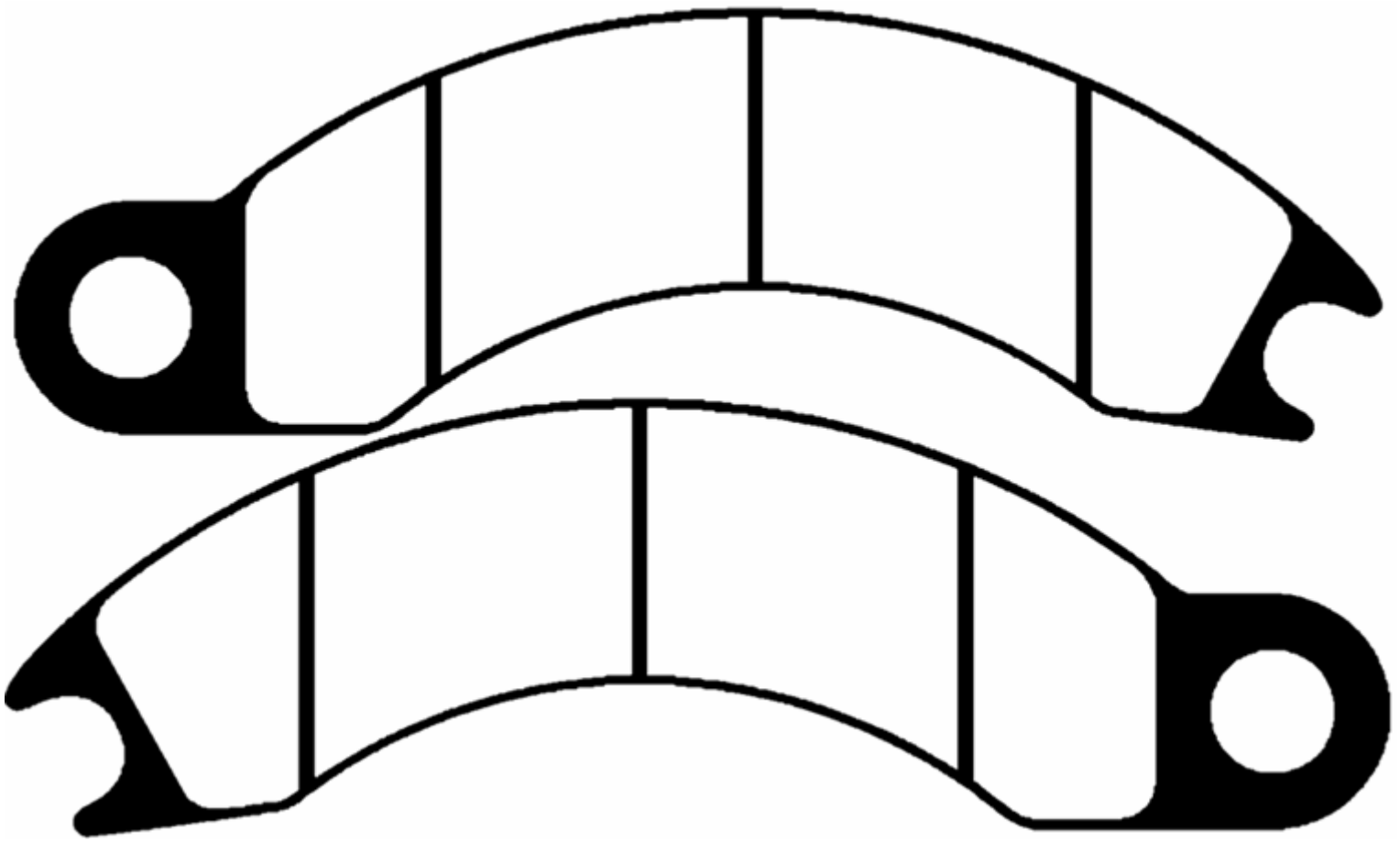

PSP401

412,6x131,7x27,0

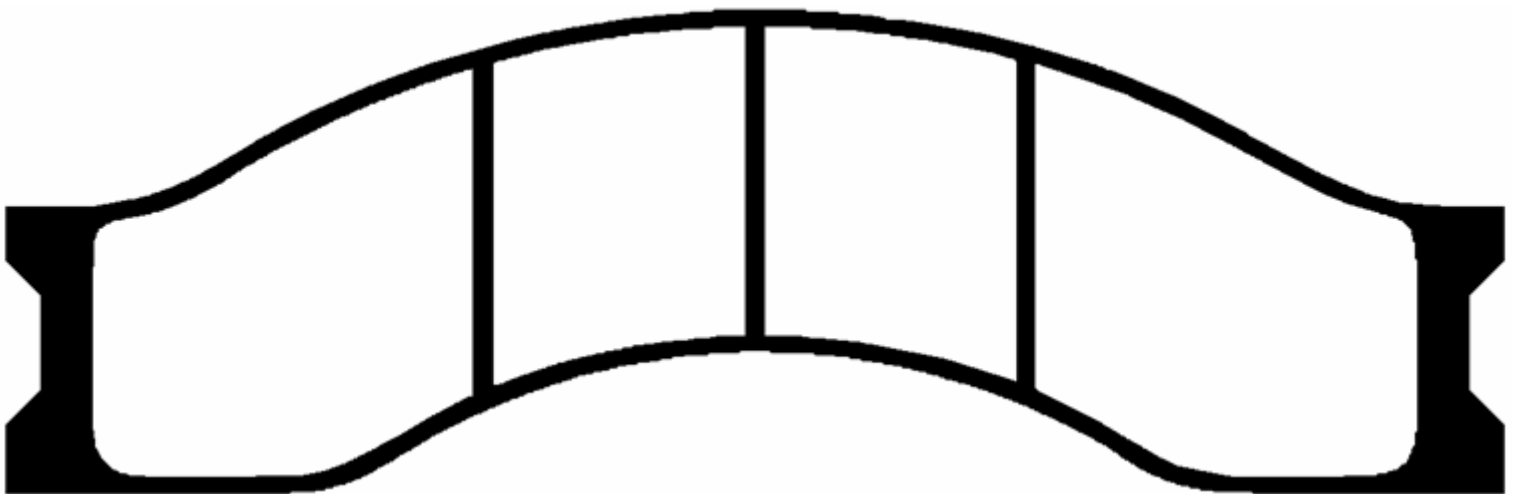

Les dessins ne sont à l'échelle 1

**PSP402**

428,0x128,5x25,0

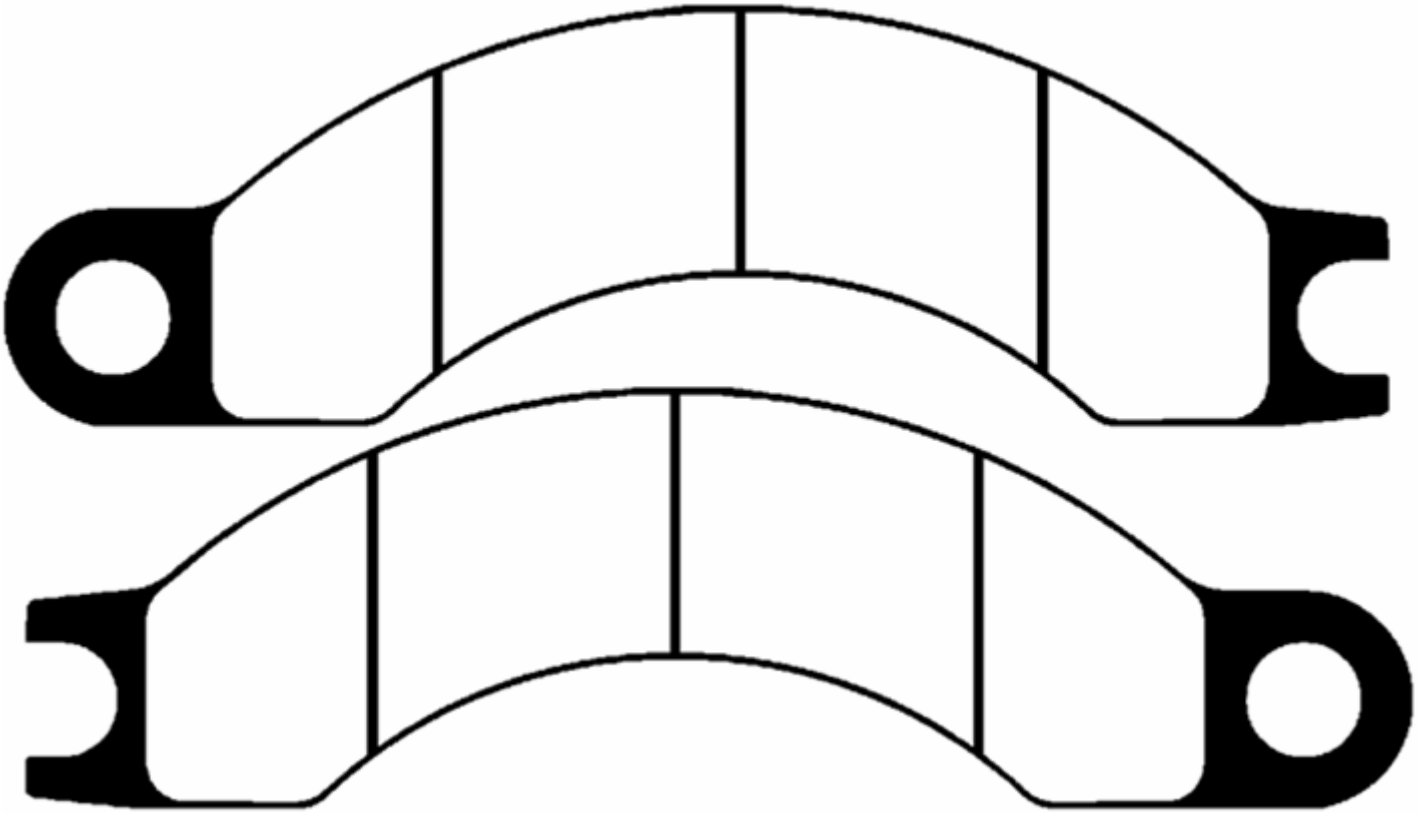

**PSP403**

445,0x143,0x25,0

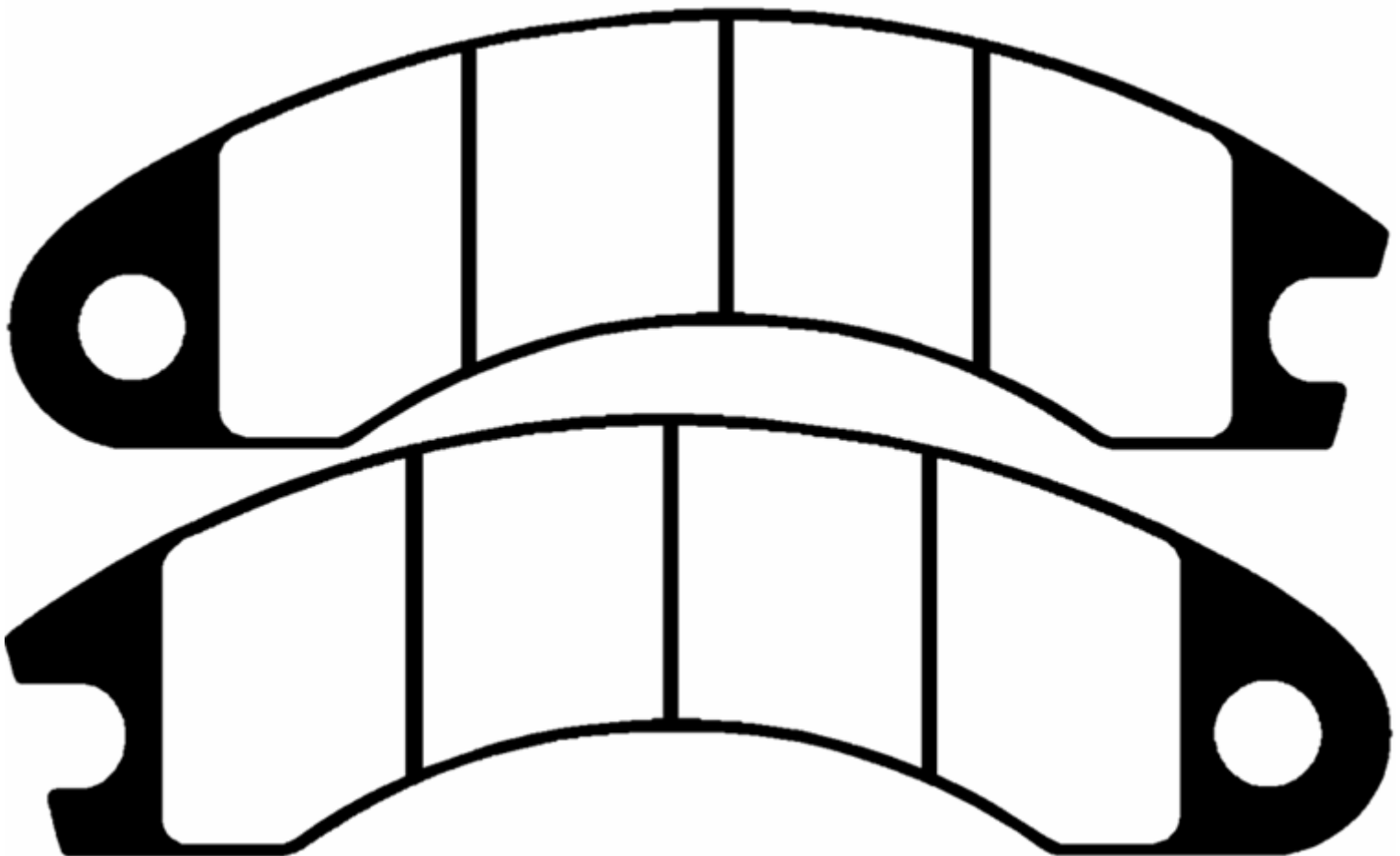



PSP404

456,0x160,0x

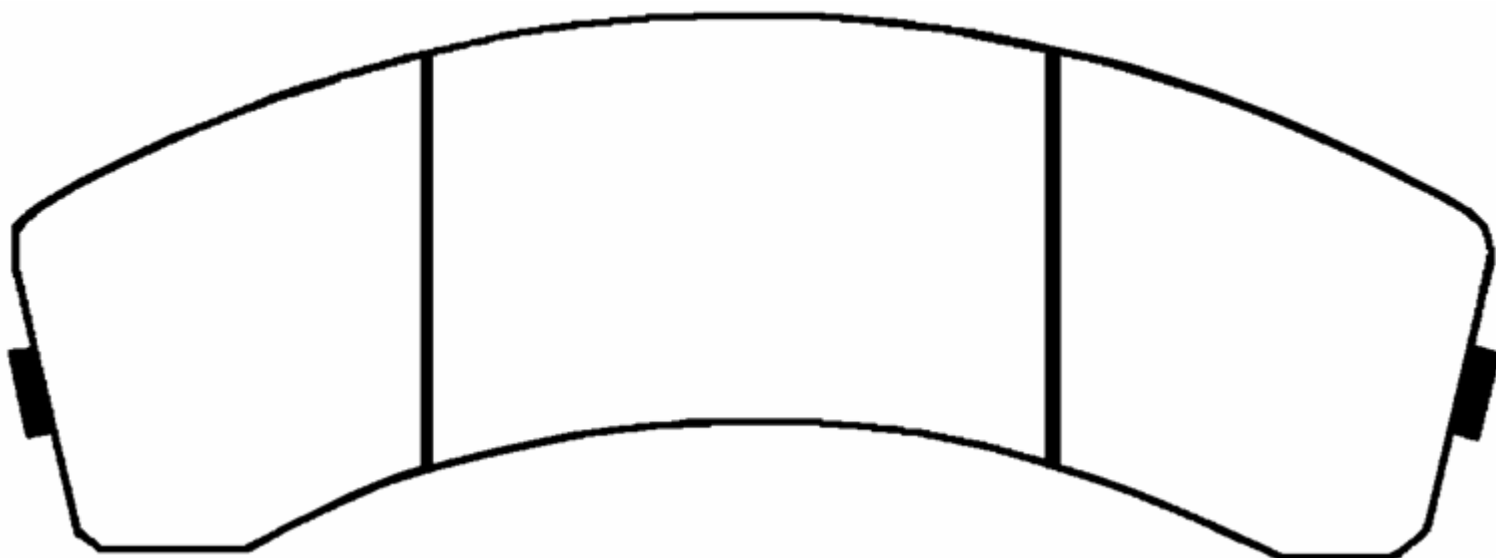

Les dessins ne sont à l'échelle 1



## CROSS REFERENCE

MAKER REF	REF GIL
15689	PSP120
20324	PSP122
20325	PSP122
20693	PSP126
20885	PSP101
22016	PSP128
22700	PSP209
28046	PSP311
28047	PSP311
28804	PSP131
29008	PSP206
29016	PSP128
29049	PSP119
29054	PSP118
29498	PSP132
29510	PSP310
29581	PSP008
29688	PSP104
29747	PSP120
52096	PSP209
52098	PSP131
52141	PSP115
52142	PSP116
52143	PSP123
52144	PSP124
52148	PSP101
52157	PSP210
52170	PSP202
52179	PSP103
52253	PSP011
52900	PSP311
52901	PSP311
52902	PSP306
52903	PSP306
52963	PSP109
52990	PSP103
212476	PSP116
221876	PSP210
244214	PSP209
244252	PSP131
244440	PSP209
244454	PSP131
244455	PSP108
244461	PSP308
244462	PSP308
244482	PSP308
244510	PSP404
244525	PSP306
244559	PSP404
244560	PSP209
244569	PSP208

MAKER REF	REF GIL
244589	PSP308
244728	PSP209
244736	PSP131
244737	PSP209
244746	PSP404
244747	PSP209
244759	PSP108
244761	PSP404
244780	PSP208
298084	PSP131
343691	PSP209
350350	PSP104
351228	PSP120
351636	PSP132
351690	PSP120
353957	PSP311
353958	PSP311
445177	PSP302
445581	PSP302
500143	PSP131
663076	PSP210
840472	PSP131
840611	PSP209
840780	PSP305
840793	PSP210
840954	PSP311
840955	PSP311
840968	PSP210
841205	PSP210
841205	PSP305
841215	PSP305
841241	PSP210
841367	PSP209
841367	PSP401
841408	PSP210
841415	PSP305
911724	PSP131
912621	PSP305
912780	PSP308
913140	PSP305
913742	PSP404
913998	PSP404
914047	PSP305
914430	PSP208
914615	PSP305
914715	PSP305
915198	PSP305
915237	PSP308
915238	PSP208
915239	PSP404
915409	PSP305

MAKER REF	REF GIL
960158	PSP305
1282020	PSP123
1410257	PSP116
1413022	PSP123
1694347	PSP123
1694946	PSP103
1696442	PSP123
1696717	PSP306
1906118	PSP104
1916685	PSP131
1990633	PSP108
2087690	PSP116
2087810	PSP123
2107384	PSP210
2215560	PSP311
2215570	PSP311
2444801	PSP311
2444802	PSP311
2445171	PSP311
2445172	PSP311
2445251	PSP306
2445252	PSP306
2445261	PSP306
2445262	PSP306
2445691	PSP208
2445801	PSP311
2445802	PSP311
2445803	PSP311
2445804	PSP311
2447301	PSP311
2447302	PSP311
2447311	PSP306
2447312	PSP306
2447331	PSP403
2447332	PSP403
2447411	PSP304
2447412	PSP304
2447421	PSP402
2447422	PSP402
2447481	PSP311
2447482	PSP311
2447804	PSP210
2447806	PSP308
2447831	PSP305
2447842	PSP404
2447845	PSP106
3078106	PSP115
3229031	PSP004
3403923	PSP302
3403924	PSP302
3633810	PSP311

## CROSS REFERENCE

MAKER REF	REF GIL
244584	PSP404
3640057	PSP305
4034556	PSP305
4041401	PSP308
4051356	PSP404
4061665	PSP131
4063204	PSP305
4063205	PSP305
4066902	PSP311
4066903	PSP311
4089972	PSP311
4089973	PSP311
4089982	PSP404
4093138	PSP311
4093139	PSP311
4095172	PSP210
4455251	PSP306
4455252	PSP306
4912263	PSP007
5209600	PSP209
5293505	PSP210
5293633	PSP210
5296150	PSP307
5691600	PSP311
5691700	PSP311
6213353	PSP210
6602143	PSP209
6602356	PSP131
6630406	PSP210
6630838	PSP120
7058064	PSP311
7058065	PSP311
7395780	PSP116
7399323	PSP311
7399324	PSP311
07416910	PSP209
8101084	PSP101
9051433	PSP209
9058890	PSP404
9058899	PSP404
9065346	PSP209
9630134	PSP210
9640057	PSP305
9640078	PSP210
9640102	PSP210
9640184	PSP210
9640225	PSP210
9640232	PSP305
9640249	PSP210
9640255	PSP210
9640268	PSP305

MAKER REF	REF GIL
947932	PSP209
9640352	PSP309
9640355	PSP205
9640356	PSP305
9640378	PSP210
9640389	PSP305
9640391	PSP305
9640404	PSP305
9640425	PSP305
9640444	PSP305
9650256	PSP210
9650378	PSP210
9680046	PSP210
9680391	PSP305
9680436	PSP210
9680668	PSP210
11034146	PSP210
11708883	PSP107
11992515	PSP207
11992694	PSP210
11992695	PSP131
11992696	PSP209
11994540	PSP210
12182009	PSP115
12182018	PSP116
12182027	PSP124
12182030	PSP128
12182033	PSP115
12182033	PSP123
12182035	PSP116
12182052	PSP124
12182091	PSP118
12182121	PSP119
12968245	PSP304
12968246	PSP304
12969325	PSP311
12969326	PSP311
0014209020	PSP122
0014209120	PSP122
15050418	PSP209
15265398	PSP304
15266825	PSP404
31005174	PSP131
32002008	PSP123
39640074	PSP210
39640078	PSP210
39640232	PSP305
39640281	PSP305
39640378	PSP210
39640389	PSP305
39640404	PSP305

MAKER REF	REF GIL
3633829	PSP311
62133533	PSP210
66302936	PSP131
66303744	PSP209
73108446	PSP209
73147364	PSP210
73147365	PSP210
75700085	PSP101
77880000	PSP311
77881000	PSP311
79121109	PSP101
91264151	PSP209
107444110	PSP109
119901015	PSP210
119926947	PSP210
512214006	PSP209
596433501	PSP101
2200089200	PSP123
2284000182	PSP104
8284000146	PSP132
8284000196	PSP132
8284000209	PSP120
8284058203	PSP132
8285000235	PSP120
9352928696	PSP131
34441121160	PSP209
34441123122	PSP131
864220003390	PSP209
05122-14006	PSP209
06213353-3	PSP210
07.4169.10	PSP209
09C0567	PSP311
1094051M91	PSP101
1135094C1	PSP311
1135094C2	PSP311
1135094C3	PSP311
11350955C3	PSP311
1135095C1	PSP311
1135095C2	PSP311
1135095C3	PSP311
114-9297A/F	PSP403
1149297AF	PSP403
1149297AF	PSP403
1173642/C1	PSP306
1173642C1	PSP306
1173643/C1	PSP306
1173643C1	PSP306
1173654/C1	PSP311
1173654C1	PSP311
1173655/C1	PSP311
1173655C1	PSP311

## CROSS REFERENCE

MAKER REF	REF GIL
9640281	PSP305
9640287	PSP305
1228972H91	PSP209
1251177H91	PSP311
1251178H91	PSP311
1259878H1	PSP311
1259878H1	PSP311
1259879H1	PSP311
1259879H1	PSP311
1260138H1	PSP209
1260B8H1	PSP209
220-00-892-00	PSP123
244-214	PSP209
244252CHG	PSP131
244-252-CHG	PSP131
244381CHEGS1730	PSP108
244-381CHEGS1730	PSP108
244-440	PSP209
244-454	PSP131
244454CHG	PSP131
244-454-CHG	PSP131
244-455	PSP108
244-461	PSP308
244-462	PSP308
244-480-1	PSP311
244-480-2	PSP311
244-482	PSP308
244-517-1	PSP311
244-517-2	PSP311
244-525	PSP306
244-525-1	PSP306
244-525-2	PSP306
244-526-1	PSP306
244-526-2	PSP306
244-560	PSP209
244-569	PSP208
244-569-1	PSP208
244-580-1	PSP311
244-580-2	PSP311
244-580-3	PSP311
244-580-4	PSP311
244-589	PSP308
244-728	PSP209
244-730-1	PSP311
244-730-2	PSP311
244-731-1	PSP306
244-731-2	PSP306
244-733-1	PSP403
244-733-2	PSP403
244-737	PSP209
244-741-1	PSP304

MAKER REF	REF GIL
39680668	PSP210
62115324	PSP210
244-747	PSP209
244-748-1	PSP311
244-748-2	PSP311
244-759	PSP108
244-780	PSP208
244-7804	PSP210
244-7806	PSP308
244-7831	PSP305
244W547CHG	PSP207
2CV9135	PSP209
2V9135	PSP209
320.02.008	PSP123
3215377R1	PSP101
3219908R1	PSP101
3230081M91	PSP116
3230097M91	PSP123
3230265M91	PSP116
3230266M	PSP004
3232506M	PSP116
3236335M	PSP116
3236335M91	PSP123
3241204R2	PSP004
344-411-21160	PSP209
344-411-23122	PSP131
3G351110104	PSP104
3V5465	PSP131
406/1665	PSP131
4-45177	PSP302
445-525-1	PSP306
445-525-2	PSP306
4-45581	PSP302
4V7061	PSP311
4V7061	PSP311
4V-7061	PSP311
4V7062	PSP311
4V7062	PSP311
4V-7062	PSP311
4V8416	PSP306
4V-8416	PSP306
4V8417	PSP306
4V-8417	PSP306
6211532-4	PSP210
6213353-3	PSP210
6630293-6	PSP131
6630374-4	PSP209
7399-323	PSP311
7399-324	PSP311
7912110-9	PSP101
7K4941	PSP131

MAKER REF	REF GIL
11990101-5	PSP210
11992694-7	PSP210
88221C1	PSP108
895977C1	PSP131
8R0807	PSP131
8R0821	PSP209
8W4938	PSP311
8W4939	PSP311
935-2928696	PSP131
939097C2	PSP209
9C0566	PSP311
9C0566/09C0567	PSP311
9C8021	PSP306
9C8022	PSP306
A0054206820	PSP120
A13222X2104	PSP210
A1GUC908045	PSP101
A23222W1921	PSP210
A23222W2104	PSP210
A3222G1853	PSP305
A3222H1854	PSP305
A3222T1944	PSP305
A3222W1921	PSP210
A3222X2104	PSP210
AK0166	PSP305
AK0177	PSP308
AK1219	PSP208
AK1252	PSP308
AK1531	PSP210
AK1537	PSP305
AK1538	PSP131
AK1542	PSP209
AK1548	PSP311
AK155	PSP308
AK1550	PSP311
AK1551	PSP306
AK1552	PSP306
AK1553	PSP404
AK1560	PSP208
D0775193390	PSP209
D77519	PSP209
E12967451	PSP404
E12968371	PSP305
E12968935	PSP404
E12969239	PSP404
E12969240	PSP311
E12969241	PSP311
E12969242	PSP308
E12969243	PSP208
E12969325	PSP311
E12969326	PSP311



**Les autres pièces du frein**

Vous pouvez obtenir auprès de votre distributeur les pièces détachées composantes pour votre frein. Il est important pour garder votre matériel en fonction de vérifier à chaque changement de garnitures les autres pièces composantes du frein.

**DISQUE DE FREIN**

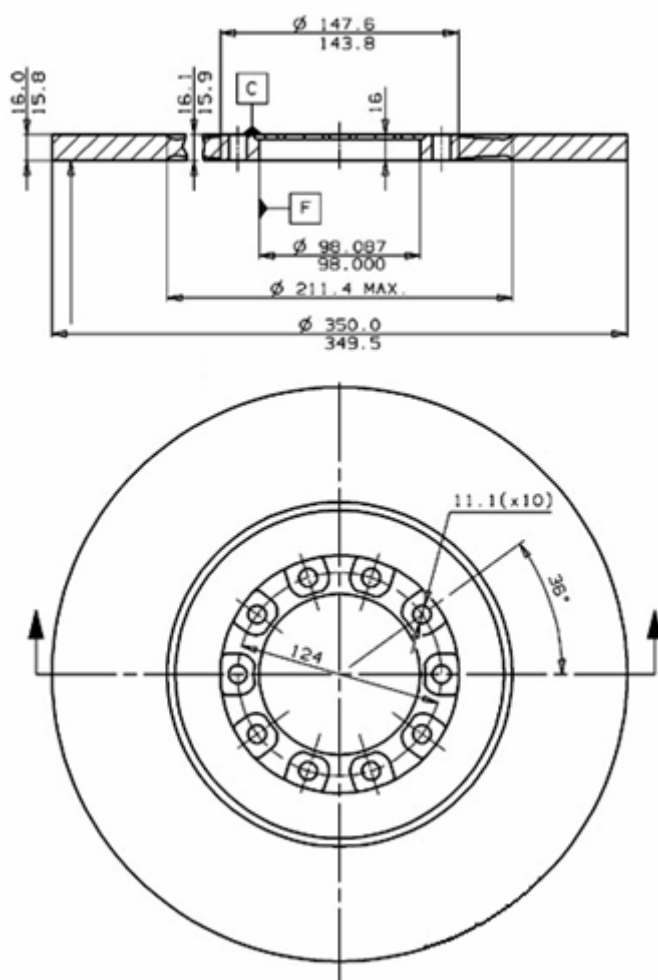

**PISTON D'ETRIER DE FREIN**

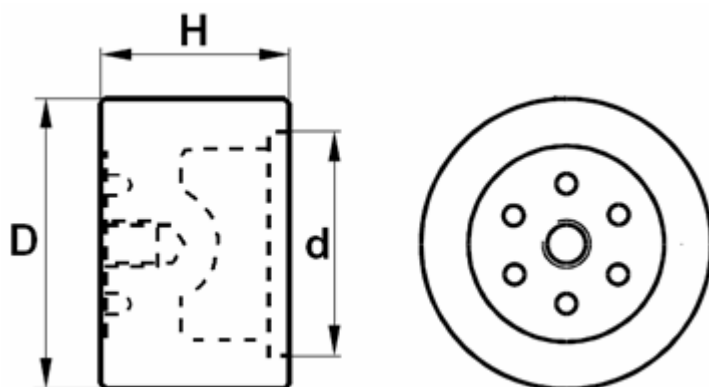

**KIT DE REPARATION D'ETRIER DE FREIN**

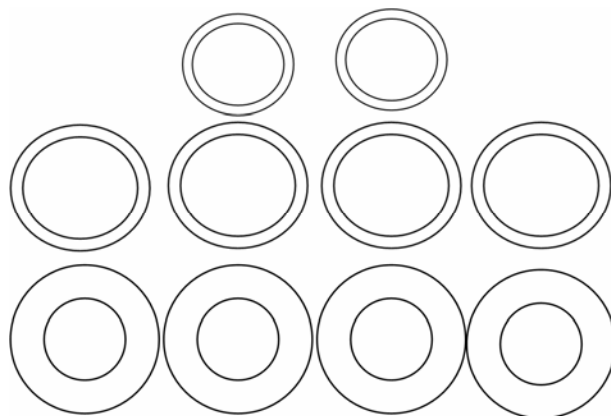

**CACHET DU DISTRIBUTEUR**

