

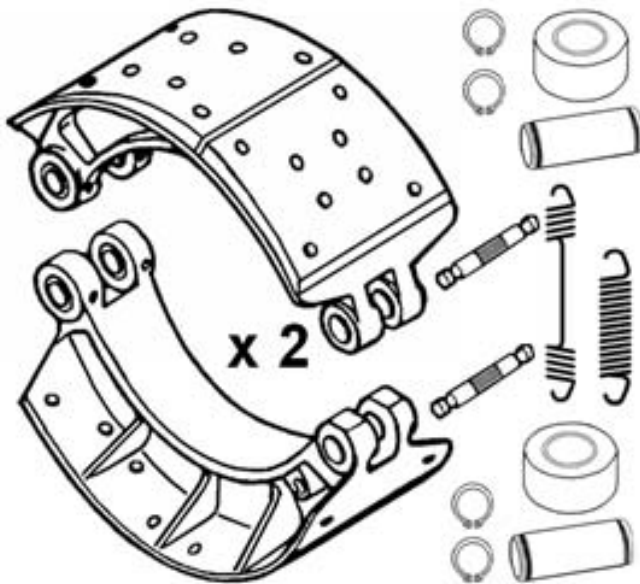

**CATALOGUE PIÈCES DE FRICTIONS A TAMBOURS POIDS LOURDS
MÂCHOIRES DE FREIN GARNIES ET KIT DE
GARNITURES AVEC ACCESSOIRES**

**CATALOG FOR CV FRICTIONS DRUM PART
CV LINED BRAKE SHOES AND CV LINING KIT
WITH FITTING KIT**

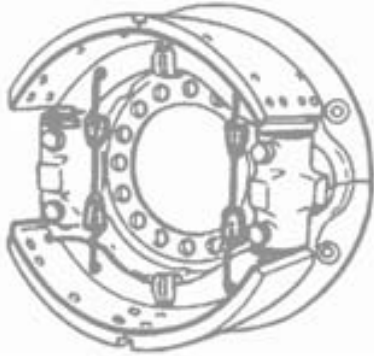

MAXIKIT FRICTION

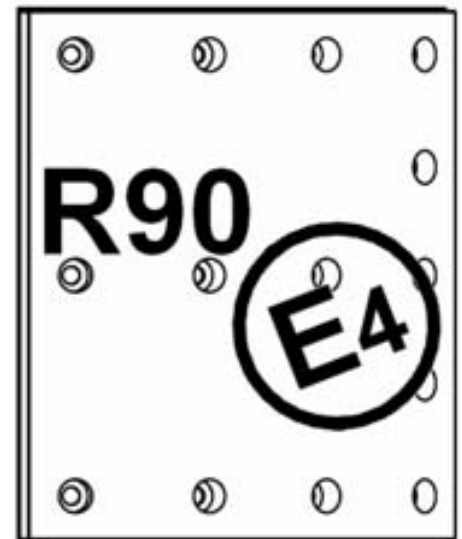

MINIKIT FRICTION

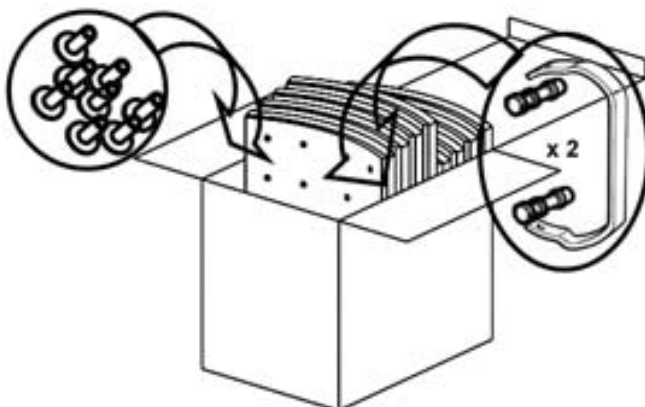



**CATALOGUE PIECES DE FRICTIONS A TAMBOURS POIDS LOURDS
MÂCHOIRES DE FREIN GARNIES ET KIT DE GARNITURES AVEC ACCESSOIRES**

**CATALOG FOR CV FRICTIONS DRUM PART
CV LINED BRAKE SHOES AND CV LINING KIT
WITH FITTING KIT**

MAXIKIT FRICTION

MINIKIT FRICTION

SOMMAIRE	PAGE
RECOMMANDATION D'USAGE	3
RECHERCHE RAPIDE (MARQUE et TYPE)	4-6
APPLICATION PAR MODELES	7-41
RECHERCHE PAR DIMENSIONS	42
RECHERCHE PAR LE NUMERO WVA	43
LISTE NUMERIQUE	44-47
CORRESPONDANCES DE REFERENCE	48-52

ABREVIATIONS

././.	SUITE
410x200	DIAMETRE TAMBOUR x LARGEUR GARNITURE
AR	ESSIEU ARRIERE
AR2	DEUXIEME ESSIEU ARRIERE
AV	ESSIEU AVANT
AV/AR	ESSIEU AVANT ET ARRIERE
AV2	DEUXIEME ESSIEU AVANT
Ch.n°: <	AVANT LE CHASSIS NUMERO
Ch.n°: >	APRES LE CHASSIS NUMERO
ROCKWELL 1	1 = PREMIER MONTAGE
ROCKWELL 2	2 = DEUXIEME MONTAGE

EXPLICATIONS DES REFERENCES

MNG	MINIKIT FRICTION
MXM	MAXIKIT FRICTION

Prenez quelques minutes à lire les recommandations d'usage pour le montage des garnitures de frein pour les freins à tambours.

La plupart de ces recommandations sont applicables pour d'autres freins à tambours.

Nous avons réalisés ces kits de frictions avec le plus grand soin afin de vous assurer la plus grande satisfaction client.

Ces kits peuvent équiper les Porteurs, Tracteurs, Cars & Bus.

Les produits composants ces kits sont issus de producteurs du **premier équipement (OEM)**.

Les garnitures de frein sont conformes au règlement Européen **UNECE R90**.

Quand faut il changer ces garnitures ?

L'épaisseur minimum est de **5 mm** ou 1 mm au dessus de la tête de rivet

Changez vos garnitures si elles présentent un glaçage.

Ce phénomène sous-entend un problème de mâchoires ou un problème de commande du frein. Vérifier les mâchoires et les pièces de commande du frein.

Les garnitures ne doivent pas avoir de fissures (notamment sur la tranche).

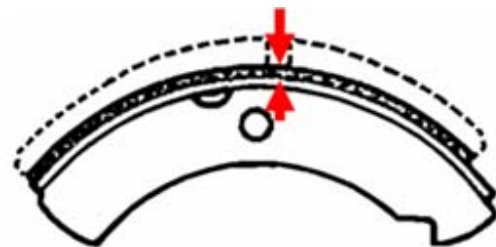

Toutes usures anormales de la garniture, vous imposent de vérifier les mâchoires et ensuite les pièces de commande du frein.

Comment réaliser un rivetage adéquat ?

Vous devez utiliser un rivet adéquat au type de garniture.

La pression de rivetage doit être à environ 800 KgF.

Vous pouvez précontraindre les garnitures avant rivetage.

Veuillez commencer votre rivetage toujours du centre vers l'extérieur.

L'écart maximum entre la garniture et la mâchoire ne doit pas dépasser **0,15 mm**.

Un écart de 0,20 mm est autorisé sur les extrémités extérieures.

Prendre soin de vérifier la qualité du rivetage.

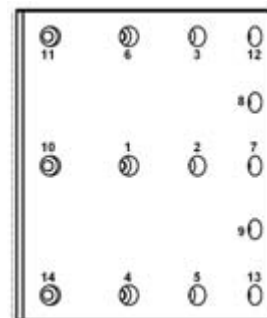

Quels points faut-il vérifier sur une mâchoire ?

Le support (jante) de la mâchoire de frein ne doit pas être concave.

Aucun défaut d'assemblage ne doit être constaté.

L'ensemble de la mâchoire de frein ne doit pas être déformé.

Les alésages et les trous de perçage des rivets ne doit pas être ni ovalisé, ni déformé.

Les mâchoires de frein doivent être bien nettoyées.

Il est possible de traiter la surface d'appui avec un produit anticorrosion.

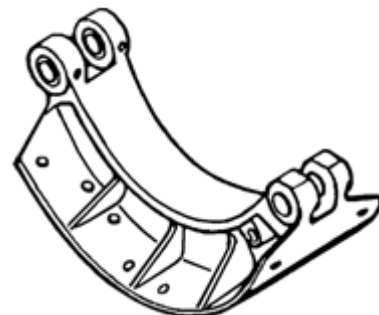

Pourquoi changer les ressorts et autres accessoires ?



Les ressorts de rappel de mâchoires permettent un retour efficace et rapide après action, pour un meilleur refroidissement et moindre d'usure.

Les galets doivent être libre en rotation, sans exempt de déformation.

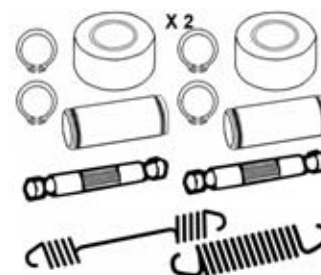

En cas de doute sur une pièce, changez là.



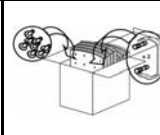
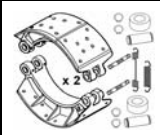

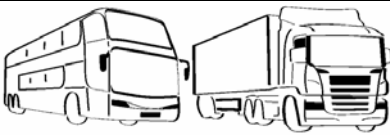

RECHERCHE RAPIDE (MARQUE et TYPE)

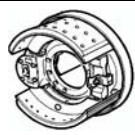
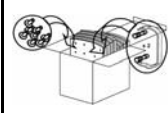
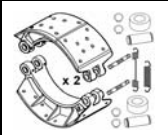
				WVA		
DAF	1900	AV	420x150 DAF	19010/19011	MNG90100	MXM90100
DAF	2300	AV	420x150 DAF	19010/19011	MNG90100	MXM90100
DAF	2300	AR	420x200 DAF	19063/19064	MNG90630	MXM90630
DAF	2500	AV	420x150 DAF	19010/19011	MNG90100	MXM90100
DAF	2700	AV	420x150 DAF	19010/19011	MNG90100	MXM90100
DAF	2700	AR	420x200 DAF	19063/19064	MNG90630	MXM90630
DAF	2900	AV	420x150 DAF	19010/19011	MNG90100	MXM90100
DAF	2900	AR	420x200 DAF	19063/19064	MNG90630	MXM90630
DAF	50 F	AV/AR	360x170 PERROT	19503	MNG95030	MXM95030
DAF	55 F	AR	360x170 PERROT	19503	MNG95030	MXM95030
DAF	65 F	AV	420x150 DAF	19010/19011	MNG90100	MXM90100
DAF	65 F	AR	420x200 DAF	19063/19064	MNG90630	MXM90630
DAF	75 F	AV	420x150 DAF	19010/19011	MNG90100	MXM90100
DAF	75 F	AR	420x150 DAF	19010/19011	MNG90100	MXM90100
DAF	75 F	AR	420x200 DAF	19063/19064	MNG90630	MXM90630
DAF	85 F	AV	420x150 DAF	19010/19011	MNG90100	MXM90100
DAF	85 F	AR	420x150 DAF	19010/19011	MNG90100	MXM90100
DAF	85 F	AR	420x200 DAF	19063/19064	MNG90630	MXM90630
DAF	95 F	AV	420x150 DAF	19010/19011	MNG90100	MXM90100
DAF	95 F	AV	420x200 DAF	19063/19064	MNG90630	MXM90630
DAF	95 F	AR	420x150 DAF	19010/19011	MNG90100	MXM90100
DAF	95 F	AR	420x200 DAF	19063/19064	MNG90630	MXM90630
ERF	E - SERIE	AV	410x175 MERITOR	19090	MNG90900	MXM90900
ERF	E - SERIE	AR	410x200 MERITOR	19071	MNG90710	MXM90710
IRISBUS	AGORA	AR	414x220 RT	19187	MNG91870	MXM91870
IRISBUS	E - SERIE	AR	414x150 BENDIX	19049/19199	MNG90490	MXM90490
IRISBUS	FR 1	AR	414x175 RT	19935	MNG99350	MXM99350
IRISBUS	FR 1	AR	414x200 RT	19974	MNG99740	MXM99740
IRISBUS	FR 1	AR	414x220 RT	19187	MNG91870	MXM91870
IRISBUS	HEULIEZ	AV	414x150 BENDIX	19049/19199	MNG90490	MXM90490
IRISBUS	HEULIEZ	AV/AR	414x175 RT	19935	MNG99350	MXM99350
IRISBUS	HEULIEZ	AR	414x220 RT	19187	MNG91870	MXM91870
IRISBUS	HEULIEZ	AR	410x225 MERITOR	19068	MNG90680	MXM90680
IRISBUS	ILIADÉ	AR	414x220 RT	19187	MNG91870	MXM91870
IRISBUS	PR	AV/AR	414x150 BENDIX	19049/19199	MNG90490	MXM90490
IRISBUS	PR	AV	414x175 RT	19935	MNG99350	MXM99350
IRISBUS	PR	AR	414x200 RT	19974	MNG99740	MXM99740
IRISBUS	RECREO 2	AR	410x200 MERITOR	19071	MNG90710	MXM90710
IRISBUS	S - SERIE	AV/AR	414x150 BENDIX	19049/19199	MNG90490	MXM90490
IRISBUS	TRACER	AV/AR	414x175 RT	19935	MNG99350	MXM99350
IVECO	EUROCARGO	AR	360x170 PERROT	19503	MNG95030	MXM95030
IVECO	EUROSTAR	AR	410x182 PERROT 2	19099/19100	MNG90990	MXM90990
IVECO	EUROSTAR	AR	410x180 ROCKWELL 1	19555/19556	MNG95550	MXM95550
IVECO	EUROSTAR	AR	410x180 ROCKWELL 2	19714/19715/19556	MNG97140	MXM97140
IVECO	EUROSTAR	AR	410x200 PERROT 1	19343/19263		MXM90910
IVECO	EUROSTAR	AR	410x202 PERROT 2	19091/19098	MNG90910	MXM90910
IVECO	EUROSTAR	AR	410x200 ROCKWELL 1	19554/19553	MNG95540	MXM95540
IVECO	EUROSTAR	AR	410x200 ROCKWELL 2	19716/19717/19553	MNG97160	MXM97160
IVECO	EUROTECH	AR	410x202 PERROT 2	19091/19098	MNG90910	MXM90910
IVECO	EUROTECH	AR	410x182 PERROT 2	19099/19100	MNG90990	MXM90990
IVECO	EUROTECH MP	AR	410x180 ROCKWELL 1	19555/19556	MNG95550	MXM95550
IVECO	EUROTECH MP	AR	410x180 ROCKWELL 2	19714/19715/19556	MNG97140	MXM97140
IVECO	EUROTECH MP	AR	410x200 ROCKWELL 1	19554/19553	MNG95540	MXM95540
IVECO	EUROTECH MP	AR	410x200 ROCKWELL 2	19716/19717/19553	MNG97160	MXM97160
IVECO	EUROTECH MP	AR	410x180 PERROT 1	19342/19262		MXM90990
IVECO	EUROTECH MP	AR	410x182 PERROT 2	19099/19100	MNG90990	MXM90990
IVECO	EUROTECH MP	AR	410x200 PERROT 1	19343/19263		MXM90910
IVECO	EUROTECH MP	AR	410x202 PERROT 2	19091/19098	MNG90910	MXM90910
IVECO	EUROTECH MT	AR	410x180 ROCKWELL 1	19555/19556	MNG95550	MXM95550
IVECO	EUROTECH MT	AR	410x180 ROCKWELL 2	19714/19715/19556	MNG97140	MXM97140

RECHERCHE RAPIDE (MARQUE et TYPE)

				WVA		
IVECO	EUROTECH MT	AR	410x200 ROCKWELL 1	19554/19553	MNG95540	MXM95540
IVECO	EUROTECH MT	AR	410x200 ROCKWELL 2	19716/19717/19553	MNG97160	MXM97160
IVECO	EUROTRAKKER	AV	410x200 PERROT 1	19343/19263		MXM90910
IVECO	EUROTRAKKER	AV	410x200 ROCKWELL 1	19554/19553	MNG95540	MXM95540
IVECO	EUROTRAKKER	AV	410x200 ROCKWELL 2	19716/19717/19553	MNG97160	MXM97160
IVECO	EUROTRAKKER	AR	410x200 PERROT 1	19343/19263		MXM90910
IVECO	EUROTRAKKER	AR	410x200 ROCKWELL 1	19554/19553	MNG95540	MXM95540
IVECO	EUROTRAKKER	AR	410x200 ROCKWELL 2	19716/19717/19553	MNG97160	MXM97160
RENAULT TRUCKS	BERLIET	AV/AR	414x150 BENDIX	19049/19199	MNG90490	MXM90490
RENAULT TRUCKS	C - RANGE	AV	414x150 BENDIX	19049/19199	MNG90490	MXM90490
RENAULT TRUCKS	C - RANGE	AV	414x150 RT	19934	MNG99340	MXM99340
RENAULT TRUCKS	C - RANGE	AV	414x175 RT	19935	MNG99350	MXM99350
RENAULT TRUCKS	C - RANGE	AR	414x150 BENDIX	19049/19199	MNG90490	MXM90490
RENAULT TRUCKS	C - RANGE	AR	414x150 RT	19934	MNG99340	MXM99340
RENAULT TRUCKS	C - RANGE	AR	414x175 RT	19935	MNG99350	MXM99350
RENAULT TRUCKS	G - MANAGER	AV	414x150 BENDIX	19049/19199	MNG90490	MXM90490
RENAULT TRUCKS	G - MANAGER	AV	414x150 RT	19934	MNG99340	MXM99340
RENAULT TRUCKS	G - MANAGER	AV	414x175 RT	19935	MNG99350	MXM99350
RENAULT TRUCKS	G - MANAGER	AR	414x175 RT	19935	MNG99350	MXM99350
RENAULT TRUCKS	G - MANAGER	AR	414x150 RT	19934	MNG99340	MXM99340
RENAULT TRUCKS	G - MAXTER	AV/AR	414x175 RT	19935	MNG99350	MXM99350
RENAULT TRUCKS	KERAX	AV	410x175 MERITOR	19090	MNG90900	MXM90900
RENAULT TRUCKS	KERAX	AV	414x175 RT	19935	MNG99350K	MXM99350K
RENAULT TRUCKS	KERAX	AR	410x225 MERITOR	19068	MNG90680	MXM90680
RENAULT TRUCKS	KERAX	AR	414x175 RT	19935	MNG99350K	MXM99350K
RENAULT TRUCKS	KERAX	AR	414x220 RT	19187	MNG91870K	MXM91870K
RENAULT TRUCKS	MAGNUM AE	AR	414x150 RT	19934	MNG99340	MXM99340
RENAULT TRUCKS	MAGNUM AE	AR	414x175 RT	19935	MNG99350	MXM99350
RENAULT TRUCKS	MAGNUM AE	AR	414x220 RT	19187	MNG91870	MXM91870
RENAULT TRUCKS	MIDLINER M/S	AV	414x150 RT	19934	MNG99340	MXM99340
RENAULT TRUCKS	MIDLINER M/S	AR	360x170 BENDIX	19255/19259	MNG92550	MXM92550
RENAULT TRUCKS	MIDLINER M/S	AR	414x150 BENDIX	19049/19199	MNG90490	MXM90490
RENAULT TRUCKS	MIDLINER M/S	AR	414x150 RT	19934	MNG99340	MXM99340
RENAULT TRUCKS	MIDLINER M/S	AR	414x175 RT	19935	MNG99350	MXM99350
RENAULT TRUCKS	PREMIUM	AR	414x220 RT	19187	MNG91870	MXM91870
RENAULT TRUCKS	R - MAJOR	AV	414x150 BENDIX	19049/19199	MNG90490	MXM90490
RENAULT TRUCKS	R - MAJOR	AV	414x150 RT	19934	MNG99340	MXM99340
RENAULT TRUCKS	R - MAJOR	AV	414x175 RT	19935	MNG99350	MXM99350
RENAULT TRUCKS	R - MAJOR	AR	414x150 RT	19934	MNG99340	MXM99340
RENAULT TRUCKS	R - MAJOR	AR	414x175 RT	19935	MNG99350	MXM99350
RENAULT TRUCKS	RVI	AR	360x170 BENDIX	19255/19259	MNG92550	MXM92550
RENAULT TRUCKS	SAVIEM	AV/AR	414x150 BENDIX	19049/19199	MNG90490	MXM90490
SCANIA	C-K BUS	AV	412x178 SCANIA	19931	MNG99310	MXM99310
SCANIA	C-K BUS	AR	412x254 SCANIA	19933	MNG99330	MXM99330
SCANIA	N - BUS	AV	412x178 SCANIA	19931	MNG99310	MXM99310
SCANIA	N - BUS	AR	412x254 SCANIA	19933	MNG99330	MXM99330
SCANIA	SERIE 3 - 93	AV	412x127 SCANIA	17991	MNG79910	MXM79910
SCANIA	SERIE 3 - 93	AV	412x178 SCANIA	19931	MNG99310	MXM99310
SCANIA	SERIE 3 - 93	AR	412x127 SCANIA	17991	MNG79910	MXM79910
SCANIA	SERIE 3 - 93	AR	412x178 SCANIA	19931	MNG99310	MXM99310
SCANIA	SERIE 3 - 93	AR	412x203 SCANIA	19932	MNG99320	MXM99320
SCANIA	SERIE 3 - 113	AV	412x127 SCANIA	17991	MNG79910	MXM79910
SCANIA	SERIE 3 - 113	AV	412x178 SCANIA	19931	MNG99310	MXM99310
SCANIA	SERIE 3 - 113	AR	412x127 SCANIA	17991	MNG79910	MXM79910
SCANIA	SERIE 3 - 113	AR	412x178 SCANIA	19931	MNG99310	MXM99310
SCANIA	SERIE 3 - 113	AR	412x203 SCANIA	19932	MNG99320	MXM99320
SCANIA	SERIE 3 - 113	AR	412x254 SCANIA	19933	MNG99330	MXM99330
SCANIA	SERIE 3 - 143	AV	412x178 SCANIA	19931	MNG99310	MXM99310
SCANIA	SERIE 3 - 143	AR	412x127 SCANIA	17991	MNG79910	MXM79910
SCANIA	SERIE 3 - 143	AR	412x178 SCANIA	19931	MNG99310	MXM99310

RECHERCHE RAPIDE (MARQUE et TYPE)

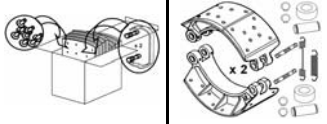
							
SCANIA	SERIE 3 - 143	AR	412x203	SCANIA	19932	MNG99320	MXM99320
SCANIA	SERIE 3 - 143	AR	412x254	SCANIA	19933	MNG99330	MXM99330
SCANIA	SERIE 4 - 94	AV	412x178	SCANIA	19931	MNG99310	MXM99310
SCANIA	SERIE 4 - 94	AV	412x203	SCANIA	19932	MNG99320	MXM99320
SCANIA	SERIE 4 - 94	AR	412x254	SCANIA	19933	MNG99330	MXM99330
SCANIA	SERIE 4 - 94	AR	412x127	SCANIA	17991	MNG79910	MXM79910
SCANIA	SERIE 4 - 94	AR	412x203	SCANIA	19932	MNG99320	MXM99320
SCANIA	SERIE 4 - 94	AR	412x178	SCANIA	19931	MNG99310	MXM99310
SCANIA	SERIE 4 - 114	AV	412x178	SCANIA	19931	MNG99310	MXM99310
SCANIA	SERIE 4 - 114	AV	412x203	SCANIA	19932	MNG99320	MXM99320
SCANIA	SERIE 4 - 114	AR	412x127	SCANIA	17991	MNG79910	MXM79910
SCANIA	SERIE 4 - 114	AR	412x178	SCANIA	19931	MNG99310	MXM99310
SCANIA	SERIE 4 - 114	AR	412x203	SCANIA	19932	MNG99320	MXM99320
SCANIA	SERIE 4 - 114	AR	412x254	SCANIA	19933	MNG99330	MXM99330
SCANIA	SERIE 4 - 124	AV	412x178	SCANIA	19931	MNG99310	MXM99310
SCANIA	SERIE 4 - 124	AV	412x203	SCANIA	19932	MNG99320	MXM99320
SCANIA	SERIE 4 - 124	AR	412x127	SCANIA	17991	MNG79910	MXM79910
SCANIA	SERIE 4 - 124	AR	412x178	SCANIA	19931	MNG99310	MXM99310
SCANIA	SERIE 4 - 124	AR	412x203	SCANIA	19932	MNG99320	MXM99320
SCANIA	SERIE 4 - 124	AR	412x254	SCANIA	19933	MNG99330	MXM99330
SCANIA	SERIE 4 - 144	AV	412x178	SCANIA	19931	MNG99310	MXM99310
SCANIA	SERIE 4 - 144	AV	412x203	SCANIA	19932	MNG99320	MXM99320
SCANIA	SERIE 4 - 144	AR	412x178	SCANIA	19931	MNG99310	MXM99310
SCANIA	SERIE 4 - 144	AR	412x203	SCANIA	19932	MNG99320	MXM99320
SCANIA	SERIE 4 - 144	AR	412x254	SCANIA	19933	MNG99330	MXM99330
VOLVO TRUCKS	B-SERIE	AV	410x150	MERITOR	19941	MNG99410	MXM99410
VOLVO TRUCKS	B-SERIE	AV	410x175	MERITOR	19090	MNG90900	MXM90900
VOLVO TRUCKS	B-SERIE	AV	410x200	MERITOR	19071	MNG90710	MXM90710
VOLVO TRUCKS	B-SERIE	AR	410x175	MERITOR	19090	MNG90900	MXM90900
VOLVO TRUCKS	B-SERIE	AR	410x225	MERITOR	19068	MNG90680	MXM90680
VOLVO TRUCKS	F - SERIE	AV	410x150	MERITOR	19941	MNG99410	MXM99410
VOLVO TRUCKS	F - SERIE	AV	410x175	MERITOR	19090	MNG90900	MXM90900
VOLVO TRUCKS	F - SERIE	AV	410x200	MERITOR	19071	MNG90710	MXM90710
VOLVO TRUCKS	F - SERIE	AV	410x225	MERITOR	19068	MNG90680	MXM90680
VOLVO TRUCKS	F - SERIE	AR	410x150	MERITOR	19941	MNG99410	MXM99410
VOLVO TRUCKS	F - SERIE	AR	410x175	MERITOR	19090	MNG90900	MXM90900
VOLVO TRUCKS	F - SERIE	AR	410x200	MERITOR	19071	MNG90710	MXM90710
VOLVO TRUCKS	F - SERIE	AR	410x225	MERITOR	19068	MNG90680	MXM90680
VOLVO TRUCKS	FH 12/16	AV	410x175	MERITOR	19090	MNG90900	MXM90900
VOLVO TRUCKS	FH 12/16	AV	410x200	MERITOR	19071	MNG90710	MXM90710
VOLVO TRUCKS	FH 12/16	AR2	410x125	MERITOR	17992	MNG79920	MXM79920
VOLVO TRUCKS	FH 12/16	AR	410x200	MERITOR	19071	MNG90710	MXM90710
VOLVO TRUCKS	FH 12/16	AR	410x225	MERITOR	19068	MNG90680	MXM90680
VOLVO TRUCKS	FL 12/16	AV	410x175	MERITOR	19090	MNG90900	MXM90900
VOLVO TRUCKS	FL 12/16	AR	410x225	MERITOR	19068	MNG90680	MXM90680
VOLVO TRUCKS	FM 12/16	AV	410x175	MERITOR	19090	MNG90900	MXM90900
VOLVO TRUCKS	FM 12/16	AR	410x200	MERITOR	19071	MNG90710	MXM90710
VOLVO TRUCKS	FM 12/16	AR	410x225	MERITOR	19068	MNG90680	MXM90680
VOLVO TRUCKS	FM 7	AV	410x175	MERITOR	19090	MNG90900	MXM90900
VOLVO TRUCKS	FM 7	AR	410x200	MERITOR	19071	MNG90710	MXM90710
VOLVO TRUCKS	FM 7	AR	410x225	MERITOR	19068	MNG90680	MXM90680
VOLVO TRUCKS	N - SERIE	AV	410x150	MERITOR	19941	MNG99410	MXM99410
VOLVO TRUCKS	N - SERIE	AV	410x175	MERITOR	19090	MNG90900	MXM90900
VOLVO TRUCKS	N - SERIE	AV	410x200	MERITOR	19071	MNG90710	MXM90710
VOLVO TRUCKS	N - SERIE	AV	410x225	MERITOR	19068	MNG90680	MXM90680
VOLVO TRUCKS	N - SERIE	AR	410x150	MERITOR	19941	MNG99410	MXM99410
VOLVO TRUCKS	N - SERIE	AR	410x175	MERITOR	19090	MNG90900	MXM90900
VOLVO TRUCKS	N - SERIE	AR	410x200	MERITOR	19071	MNG90710	MXM90710
VOLVO TRUCKS	N - SERIE	AR	410x225	MERITOR	19068	MNG90680	MXM90680

APPLICATION PAR MODELES

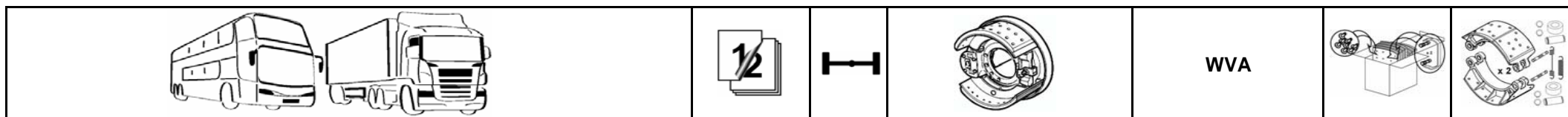

DAF								
1900								
FA 1900-NS, FT 1900-NS, FA 1905, FT 1905	11.89-09.93	AV	420x150	DAF	19010/19011	MNG90100	MXM90100	
FA/FT 1900-NS, FA1905	11.89-09.93	AV	420x150	DAF	19010/19011	MNG90100	MXM90100	
2300								
F 2300	11.89-09.93	AV	420x150	DAF	19010/19011	MNG90100	MXM90100	
F 2300	11.89-	AR	420x200	DAF	19063/19064	MNG90630	MXM90630	
2500								
F 2500	02.86-09.93	AV	420x150	DAF	19010/19011	MNG90100	MXM90100	
FA 2505	11.95-09.93	AV	420x150	DAF	19010/19011	MNG90100	MXM90100	
2700								
FA/FT 2700ATi	11.89-09.93	AV	420x150	DAF	19010/19011	MNG90100	MXM90100	
FA/FT 2700ATi	11.89-	AR	420x200	DAF	19063/19064	MNG90630	MXM90630	
2900								
F 2900	11.89-09.93	AV	420x150	DAF	19010/19011	MNG90100	MXM90100	
F 2900	11.89-	AR	420x200	DAF	19063/19064	MNG90630	MXM90630	
50 F								
FA 50.130, 150, 160, 180	01.92-11.95	AV	360x170	PERROT	19503	MNG95030	MXM95030	
FA 50.130, 150, 160, 180	01.92-11.95	AR	360x170	PERROT	19503	MNG95030	MXM95030	
55 F								
FA 55.150 B13	11.95-12.00	AR	360x170	PERROT	19503	MNG95030	MXM95030	
FA 55.180 B13, FA 55.180 B15	11.95-12.00	AR	360x170	PERROT	19503	MNG95030	MXM95030	
FA 55.210 B13, FA 55.210 B15, FAG 55.210 B 21	11.95-12.00	AR	360x170	PERROT	19503	MNG95030	MXM95030	
FA 55.230 B13, FA 55.230 B15	11.95-12.00	AR	360x170	PERROT	19503	MNG95030	MXM95030	
65 F								
FA 65.180, FAV 65.180	1993-1998	AV	420x150	DAF	19010/19011	MNG90100	MXM90100	
FA 65.180, FAV 65.180	1993-1998	AR	420x200	DAF	19063/19064	MNG90630	MXM90630	
FA 65.210, FA 65.240	1993-1998	AV	420x150	DAF	19010/19011	MNG90100	MXM90100	
FA 65.210, FA 65.240	1993-1998	AR	420x200	DAF	19063/19064	MNG90630	MXM90630	
FA CF65-180, FAV CF65-180 (4x2)	1998-2000	AV	420x150	DAF	19010/19011	MNG90100	MXM90100	
FA CF65-180, FAV CF65-180 (4x2)	1998-2000	AR	420x200	DAF	19063/19064	MNG90630	MXM90630	
FA CF65-210, FAV CF65-210 (4x2)	1998-2000	AV	420x150	DAF	19010/19011	MNG90100	MXM90100	
FA CF65-210, FAV CF65-210 (4x2)	1998-2000	AR	420x200	DAF	19063/19064	MNG90630	MXM90630	
FA CF65-240 (4x2)	1998-2000	AV	420x150	DAF	19010/19011	MNG90100	MXM90100	
FA CF65-240 (4x2)	1998-2000	AR	420x200	DAF	19063/19064	MNG90630	MXM90630	
75 F								
CF75-250, 290, 320 (4x2)	02.98-12.00	AV	420x150	DAF	19010/19011	MNG90100	MXM90100	
CF75-250, 290, 320 (4x2)	02.98-12.00	AR	420x200	DAF	19063/19064	MNG90630	MXM90630	

APPLICATION PAR MODELES

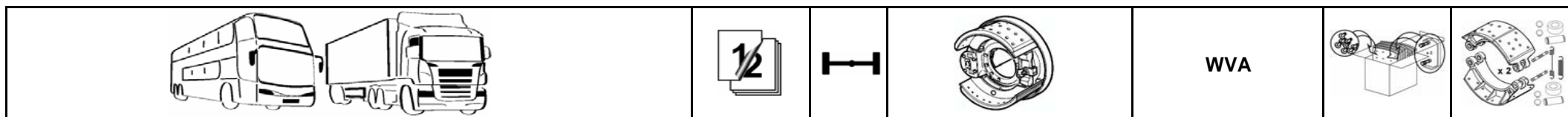

Model	Year	Code	Size	Brand	WVA	Part 1	Part 2
DAF/75 F/							
CF75-250, 290, 320 (6x4)	02.98-12.00	AR2	420x200	DAF	19063/19064	MNG90630	MXM90630
CF75-250, 290, 320 (6x4)	02.98-12.00	AR	420x200	DAF	19063/19064	MNG90630	MXM90630
FA 75.240, FAV 75.240 (4x2, 4x4)	07.92-02.98	AV	420x150	DAF	19010/19011	MNG90100	MXM90100
FA 75.240, FAV 75.240 (4x2, 4x4)	07.92-02.98	AR	420x200	DAF	19063/19064	MNG90630	MXM90630
FA/FT 75.300 (4x2, 4x4)	07.92-02.98	AV	420x150	DAF	19010/19011	MNG90100	MXM90100
FA/FT 75.300 (4x2, 4x4)	07.92-02.98	AR	420x200	DAF	19063/19064	MNG90630	MXM90630
FAG/FAN 75.240, 75.270, 75.300 (6x2/4)	07.92-02.98	AR2	420x150	DAF	19010/19011	MNG90100	MXM90100
FAG/FAN 75.240, 75.270, 75.300 (6x2/4)	07.92-02.98	AR	420x200	DAF	19063/19064	MNG90630	MXM90630
FAG/FAN CF75-250, 290, 320 (6x2/4)	02.98-12.00	AR2	420x150	DAF	19010/19011	MNG90100	MXM90100
FAG/FAN CF75-250, 290, 320 (6x2/4)	02.98-12.00	AR	420x200	DAF	19063/19064	MNG90630	MXM90630
FAR/FAS 75.240, 75.270, 75.300 (6x2)	07.92-02.98	AV	420x150	DAF	19010/19011	MNG90100	MXM90100
FAR/FAS 75.240, 75.270, 75.300 (6x2)	07.92-02.98	AR2	420x150	DAF	19010/19011	MNG90100	MXM90100
FAR/FAS 75.240, 75.270, 75.300 (6x2)	07.92-02.98	AR	420x200	DAF	19063/19064	MNG90630	MXM90630
FAR/FAS CF75-250, 290, 320 (6x2)	02.98-12.00	AV	420x150	DAF	19010/19011	MNG90100	MXM90100
FAR/FAS CF75-250, 290, 320 (6x2)	02.98-12.00	AR2	420x150	DAF	19010/19011	MNG90100	MXM90100
FAR/FAS CF75-250, 290, 320 (6x2)	02.98-12.00	AR	420x200	DAF	19063/19064	MNG90630	MXM90630
FAT 75.270 (6x4)	07.92-02.98	AR2	420x200	DAF	19063/19064	MNG90630	MXM90630
FAT 75.270 (6x4)	07.92-02.98	AR	420x200	DAF	19063/19064	MNG90630	MXM90630
FT 75.240 (4x2, 4x4)	07.92-02.98	AV	420x150	DAF	19010/19011	MNG90100	MXM90100
FT 75.240 (4x2, 4x4)	07.92-02.98	AR	420x200	DAF	19063/19064	MNG90630	MXM90630
FT/FA/FAV 75.270 (4x2, 4x4)	07.92-02.98	AV	420x150	DAF	19010/19011	MNG90100	MXM90100
FT/FA/FAV 75.270 (4x2, 4x4)	07.92-02.98	AR	420x200	DAF	19063/19064	MNG90630	MXM90630
85 F							
FA 85.330-360-400 (4x2)	07.92-02.98	AV	420x150	DAF	19010/19011	MNG90100	MXM90100
FA 85.330-360-400 (4x2)	07.92-02.98	AR	420x200	DAF	19063/19064	MNG90630	MXM90630
FA/FT CF85-340, 380, 430, 480 (4x2)	02.98-12.00	AV	420x150	DAF	19010/19011	MNG90100	MXM90100
FA/FT CF85-340, 380, 430, 480 (4x2)	02.98-12.00	AR	420x200	DAF	19063/19064	MNG90630	MXM90630
FAC CF85-340, 380, 430, 480 (8x2)	02.98-12.00	AV	420x150	DAF	19010/19011	MNG90100	MXM90100
FAC CF85-340, 380, 430, 480 (8x2)	02.98-12.00	AV2	420x150	DAF	19010/19011	MNG90100	MXM90100
FAC CF85-340, 380, 430, 480 (8x2)	02.98-12.00	AR2	420x150	DAF	19010/19011	MNG90100	MXM90100
FAC CF85-340, 380, 430, 480 (8x2)	02.98-12.00	AR	420x200	DAF	19063/19064	MNG90630	MXM90630
FAD CF85-340, 380, 430, 480 (8x2)	02.98-12.00	AR	420x200	DAF	19063/19064	MNG90630	MXM90630
FAD/FAT/FTT 85.330-360-400 (6x4)	07.92-02.98	AR2	420x200	DAF	19063/19064	MNG90630	MXM90630
FAD/FAT/FTT 85.330-360-400 (6x4)	07.92-02.98	AR	420x200	DAF	19063/19064	MNG90630	MXM90630
FAG 85.330, FAG 85.360 (6x2/2/4)	07.92-02.98	AR2	420x150	DAF	19010/19011	MNG90100	MXM90100
FAG 85.330, FAG 85.360 (6x2/2/4)	07.92-02.98	AR	420x200	DAF	19063/19064	MNG90630	MXM90630

APPLICATION PAR MODELES

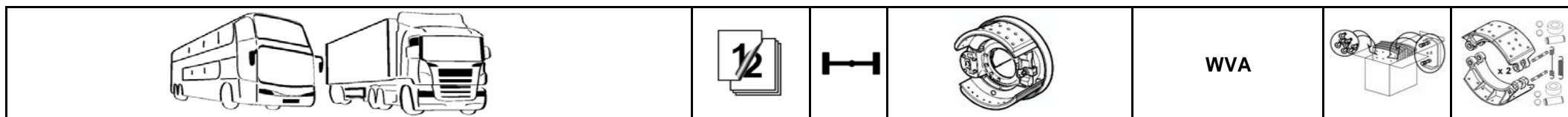

Model	Year	Code	Size	Brand	WVA	Part 1	Part 2
DAF/							
85 F/							
FAG CF85-340, 380, 430, 480 (6x2/4)	02.98-12.00	AR2	420x150	DAF	19010/19011	MNG90100	MXM90100
FAG CF85-340, 380, 430, 480 (6x2/4)	02.98-12.00	AR	420x200	DAF	19063/19064	MNG90630	MXM90630
FAG/FAR/FAS/FTG 85.330-360-400 (6x2/2/4)	07.92-02.98	AV	420x150	DAF	19010/19011	MNG90100	MXM90100
FAG/FAR/FAS/FTG 85.330-360-400 (6x2/2/4)	07.92-02.98	AR2	420x150	DAF	19010/19011	MNG90100	MXM90100
FAG/FAR/FAS/FTG 85.330-360-400 (6x2/2/4)	07.92-02.98	AR	420x200	DAF	19063/19064	MNG90630	MXM90630
FAR 85.330/360	1993-1998	AV	420x150	DAF	19010/19011	MNG90100	MXM90100
FAR 85.330/360	1993-1998	AR	420x200	DAF	19063/19064	MNG90630	MXM90630
FAR/FAS 85.330, 85.360 (6x2/2/4)	1993-1998	AV	420x150	DAF	19010/19011	MNG90100	MXM90100
FAR/FAS 85.330, 85.360 (6x2/2/4)	1993-1998	AR2	420x150	DAF	19010/19011	MNG90100	MXM90100
FAR/FAS 85.330, 85.360 (6x2/2/4)	1993-1998	AR	420x200	DAF	19063/19064	MNG90630	MXM90630
FAR/FAS/FAN/FTG CF85-340 (6x2, 6x2/4)	02.98-12.00	AV	420x150	DAF	19010/19011	MNG90100	MXM90100
FAR/FAS/FAN/FTG CF85-340 (6x2, 6x2/4)	02.98-12.00	AR2	420x150	DAF	19010/19011	MNG90100	MXM90100
FAR/FAS/FAN/FTG CF85-340 (6x2, 6x2/4)	02.98-12.00	AR	420x200	DAF	19063/19064	MNG90630	MXM90630
FAR/FAS/FAN/FTG CF85-380 (6x2, 6x2/4)	02.98-12.00	AV	420x150	DAF	19010/19011	MNG90100	MXM90100
FAR/FAS/FAN/FTG CF85-380 (6x2, 6x2/4)	02.98-12.00	AR2	420x150	DAF	19010/19011	MNG90100	MXM90100
FAR/FAS/FAN/FTG CF85-380 (6x2, 6x2/4)	02.98-12.00	AR	420x200	DAF	19063/19064	MNG90630	MXM90630
FAR/FAS/FAN/FTG CF85-430 (6x2, 6x2/4)	02.98-12.00	AV	420x150	DAF	19010/19011	MNG90100	MXM90100
FAR/FAS/FAN/FTG CF85-430 (6x2, 6x2/4)	02.98-12.00	AR2	420x150	DAF	19010/19011	MNG90100	MXM90100
FAR/FAS/FAN/FTG CF85-430 (6x2, 6x2/4)	02.98-12.00	AR	420x200	DAF	19063/19064	MNG90630	MXM90630
FAR/FAS/FAN/FTG CF85-480 (6x2, 6x2/4)	02.98-12.00	AV	420x150	DAF	19010/19011	MNG90100	MXM90100
FAR/FAS/FAN/FTG CF85-480 (6x2, 6x2/4)	02.98-12.00	AR2	420x150	DAF	19010/19011	MNG90100	MXM90100
FAR/FAS/FAN/FTG CF85-480 (6x2, 6x2/4)	02.98-12.00	AR	420x200	DAF	19063/19064	MNG90630	MXM90630
FAS 85.3	1993-1998	AV	420x150	DAF	19010/19011	MNG90100	MXM90100
FAS 85.3	1993-1998	AR	420x200	DAF	19063/19064	MNG90630	MXM90630
FAT/FTT CF85-340, 380, 430, 480 (6x4)	02.98-12.00	AR	420x200	DAF	19063/19064	MNG90630	MXM90630
95 F							
FA 95.330-360-400-430 (4x2)	08.90-01.98	AV	420x150	DAF	19010/19011	MNG90100	MXM90100
FA 95.330-360-400-430 (4x2)	08.90-01.98	AR	420x200	DAF	19063/19064	MNG90630	MXM90630
FA/FT XF95-380, 430, 480, 530 (4x2)	01.97-09.02	AV	420x150	DAF	19010/19011	MNG90100	MXM90100
FA/FT XF95-380, 430, 480, 530 (4x2)	01.97-09.02	AR	420x200	DAF	19063/19064	MNG90630	MXM90630
FAC XF95-380, 430, 480, 530 (8x2)	01.97-09.02	AV	420x150	DAF	19010/19011	MNG90100	MXM90100
FAC XF95-380, 430, 480, 530 (8x2)	01.97-09.02	AV2	420x150	DAF	19010/19011	MNG90100	MXM90100
FAC XF95-380, 430, 480, 530 (8x2)	01.97-09.02	AR2	420x150	DAF	19010/19011	MNG90100	MXM90100
FAC XF95-380, 430, 480, 530 (8x2)	01.97-09.02	AR	420x200	DAF	19063/19064	MNG90630	MXM90630
FAD 95.360-400-430 (8x4/4)	08.90-01.98	AV2	420x200	DAF	19063/19064	MNG90630	MXM90630
FAD 95.360-400-430 (8x4/4)	08.90-01.98	AR2	420x200	DAF	19063/19064	MNG90630	MXM90630

APPLICATION PAR MODELES

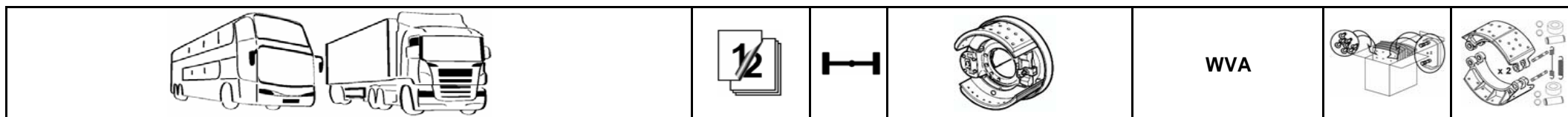

Model	Year	Code	Size	Brand	WVA	MNG	MXM
DAF ../..							
95 F ../..							
FAD 95.360-400-430 (8x4/4)	08.90-01.98	AR	420x200	DAF	19063/19064	MNG90630	MXM90630
FAD XF95-380, 430, 480 (8x4/4)	01.97-09.02	AV2	420x200	DAF	19063/19064	MNG90630	MXM90630
FAD XF95-380, 430, 480 (8x4/4)	01.97-09.02	AR2	420x200	DAF	19063/19064	MNG90630	MXM90630
FAD XF95-380, 430, 480 (8x4/4)	01.97-09.02	AR	420x200	DAF	19063/19064	MNG90630	MXM90630
FAG 95.330-360-400-430 (6x2/2/4)	08.90-01.98	AR	420x200	DAF	19063/19064	MNG90630	MXM90630
FAK 95.330-360-400-430 (8x2)	08.90-01.98	AV	420x150	DAF	19010/19011	MNG90100	MXM90100
FAK 95.330-360-400-430 (8x2)	08.90-01.98	AV2	420x150	DAF	19010/19011	MNG90100	MXM90100
FAK 95.330-360-400-430 (8x2)	08.90-01.98	AR2	420x150	DAF	19010/19011	MNG90100	MXM90100
FAK 95.330-360-400-430 (8x2)	08.90-01.98	AR	420x200	DAF	19063/19064	MNG90630	MXM90630
FAR 95.330-360-400-430, (6x2)	08.90-01.98	AV	420x150	DAF	19010/19011	MNG90100	MXM90100
FAR 95.330-360-400-430, (6x2)	08.90-01.98	AR2	420x150	DAF	19010/19011	MNG90100	MXM90100
FAR 95.330-360-400-430, (6x2)	08.90-01.98	AR	420x200	DAF	19063/19064	MNG90630	MXM90630
FAR/FAS XF95-380, 430, 480, 530 (6x2)	01.97-09.02	AV	420x150	DAF	19010/19011	MNG90100	MXM90100
FAR/FAS XF95-380, 430, 480, 530 (6x2)	01.97-09.02	AR2	420x150	DAF	19010/19011	MNG90100	MXM90100
FAR/FAS XF95-380, 430, 480, 530 (6x2)	01.97-09.02	AR	420x200	DAF	19063/19064	MNG90630	MXM90630
FAT/FTT 95.360-400-430 (6x4)	08.90-01.98	AR2	420x200	DAF	19063/19064	MNG90630	MXM90630
FAT/FTT 95.360-400-430 (6x4)	08.90-01.98	AR	420x200	DAF	19063/19064	MNG90630	MXM90630
FAT/FTT XF95-380, 430, 480, 530 (6x4)	01.97-09.02	AR2	420x200	DAF	19063/19064	MNG90630	MXM90630
FAT/FTT XF95-380, 430, 480, 530 (6x4)	01.97-09.02	AR	420x200	DAF	19063/19064	MNG90630	MXM90630
FT 95.330-360-400-430 (4x2)	08.90-01.98	AV	420x150	DAF	19010/19011	MNG90100	MXM90100
FT 95.330-360-400-430 (4x2)	08.90-01.98	AR	420x200	DAF	19063/19064	MNG90630	MXM90630
FT 95.500 (4x2)	02.94-01.98	AR	420x200	DAF	19063/19064	MNG90630	MXM90630
FTG 95.360-400-430 (6x2/4)	08.90-01.98	AR	420x200	DAF	19063/19064	MNG90630	MXM90630
FTG XF95-380, 430, 480, 530 (6x2/4)	01.97-09.02	AR	420x200	DAF	19063/19064	MNG90630	MXM90630
FTR 95.360-400-430, FTS 95.3-4 (6x2)	08.90-01.98	AV	420x150	DAF	19010/19011	MNG90100	MXM90100
FTR 95.360-400-430, FTS 95.3-4 (6x2)	08.90-01.98	AR2	420x150	DAF	19010/19011	MNG90100	MXM90100
FTR 95.360-400-430, FTS 95.3-4 (6x2)	08.90-01.98	AR	420x200	DAF	19063/19064	MNG90630	MXM90630
FTR/FTS XF95-380, 430, 480, 530 (6x2)	01.97-09.02	AV	420x150	DAF	19010/19011	MNG90100	MXM90100
FTR/FTS XF95-380, 430, 480, 530 (6x2)	01.97-09.02	AR2	420x150	DAF	19010/19011	MNG90100	MXM90100
FTR/FTS XF95-380, 430, 480, 530 (6x2)	01.97-09.02	AR	420x200	DAF	19063/19064	MNG90630	MXM90630
ERF							
E - SERIE							
E 6, E 8, E 10, E 12, E 14, E 16	1990-	AV	410x175	MERITOR	19090	MNG90900	MXM90900
E 6, E 8, E 10, E 12, E 14, E 16	1990-	AR	410x200	MERITOR	19071	MNG90710	MXM90710

APPLICATION PAR MODELES

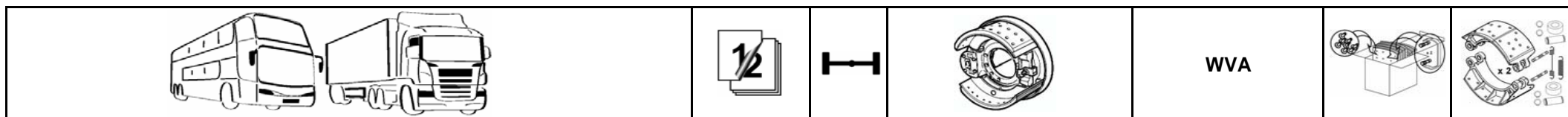

IRISBUS							
AGORA							
Agora	1995-09.98	AR	414x220	RT	19187	MNG91870	MXM91870
E - SERIE							
E 7 C	1969-	AR	414x150	BENDIX	19049/19199	MNG90490	MXM90490
E 7 L, M, N	1969-	AR	414x150	BENDIX	19049/19199	MNG90490	MXM90490
FR 1							
FR 1 E, GT/T, T1, T2, TX-GTX	05.84-12.92	AR	414x175	RT	19935	MNG99350	MXM99350
FR 1 E, GT/T, T1, T2, TX-GTX	05.84-12.92	AR	414x200	RT	19974	MNG99740	MXM99740
FR 1 (L1-L3)	01.93-	AR	414x200	RT	19974	MNG99740	MXM99740
FR 1 (L1-L3)	01.93-	AR	414x220	RT	19187	MNG91870	MXM91870
ILIADE							
ILIADE, ILIADE TE	1997-	AR	414x220	RT	19187	MNG91870	MXM91870
HEULIEZ							
GX 107, GX 113		AV	414x150	BENDIX	19049/19199	MNG90490	MXM90490
GX 117		AV	414x150	BENDIX	19049/19199	MNG90490	MXM90490
GX 117		AV	414x175	RT	19935	MNG99350	MXM99350
GX 117		AR	414x175	RT	19935	MNG99350	MXM99350
GX 187		AV	414x150	BENDIX	19049/19199	MNG90490	MXM90490
GX 217		AR	410x225	MERITOR	19068	MNG90680	MXM90680
GX 317		AR	414x220	RT	19187	MNG91870	MXM91870
GX 417		AR2	410x225	MERITOR	19068	MNG90680	MXM90680
GX 417		AR	410x225	MERITOR	19068	MNG90680	MXM90680
GX 44, GX 57		AV	414x150	BENDIX	19049/19199	MNG90490	MXM90490
GX 87		AV	414x150	BENDIX	19049/19199	MNG90490	MXM90490
PR							
PR 100, PR 100.2	1977-	AV	414x150	BENDIX	19049/19199	MNG90490	MXM90490
PR 100.3	1994-	AV	414x175	RT	19935	MNG99350	MXM99350
PR 100.3	1994-	AR	414x200	RT	19974	MNG99740	MXM99740
PR 10S, 12S, 14S, SL, PGK 205, D, S 57 L		AR	414x150	BENDIX	19049/19199	MNG90490	MXM90490
PR 112	1994-	AV	414x175	RT	19935	MNG99350	MXM99350
PR 112	1994-	AR	414x200	RT	19974	MNG99740	MXM99740
PR 118	1994-	AV	414x175	RT	19935	MNG99350	MXM99350
PR 118	1994-	AR2	414x200	RT	19974	MNG99740	MXM99740
PR 118	1994-	AR	414x200	RT	19974	MNG99740	MXM99740
PR 14 SR, SR GT		AV	414x150	BENDIX	19049/19199	MNG90490	MXM90490
PR 14 SR, SR GT		AR	414x150	BENDIX	19049/19199	MNG90490	MXM90490
PR 180		AR	414x150	BENDIX	19049/19199	MNG90490	MXM90490

APPLICATION PAR MODELES

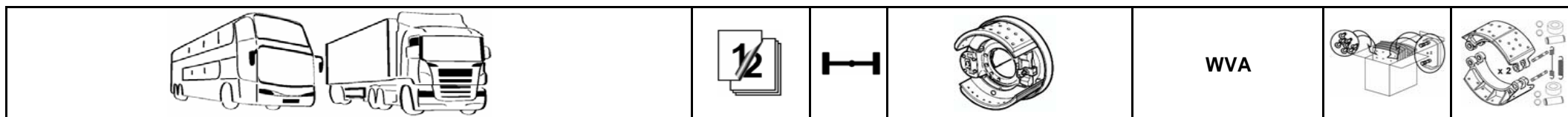

Model	Year	Code	Size	Brand	Year	Part 1	Part 2
IRISBUS ../..							
PR ../..							
PR 180, PER 180		AV	414x150	BENDIX	19049/19199	MNG90490	MXM90490
PR 180.2		AV	414x150	BENDIX	19049/19199	MNG90490	MXM90490
PR 180.3	1994-	AV	414x175	RT	19935	MNG99350	MXM99350
PR 180.3	1994-	AR2	414x200	RT	19974	MNG99740	MXM99740
PR 180.3	1994-	AR	414x200	RT	19974	MNG99740	MXM99740
RECREO 2							
Récreo 2	1998-	AR	410x200	MERITOR	19071	MNG90710	MXM90710
S - SERIE							
S 105, 108, SC 10, 45		AV	414x150	BENDIX	19049/19199	MNG90490	MXM90490
S 105, 108, SC 10, 45		AR	414x150	BENDIX	19049/19199	MNG90490	MXM90490
S 45, S 53	-1978	AV	414x150	BENDIX	19049/19199	MNG90490	MXM90490
S 45, S 53	-1978	AR	414x150	BENDIX	19049/19199	MNG90490	MXM90490
TRACER							
Tracer R 332	1991-	AV	414x175	RT	19935	MNG99350	MXM99350
Tracer R 332	1991-	AR	414x175	RT	19935	MNG99350	MXM99350
IVECO							
EUROCARGO							
120 E 15, 120 E 15 K	01.94-	AR	360x170	PERROT	19503	MNG95030	MXM95030
120 E 18, 120 E 18 K	01.91-	AR	360x170	PERROT	19503	MNG95030	MXM95030
120 E 23	01.92-	AR	360x170	PERROT	19503	MNG95030	MXM95030
130 E 15, 130 E 15 K	01.94-	AR	360x170	PERROT	19503	MNG95030	MXM95030
130 E 18 tector, 130 E 18 K tector	09.00-	AR	360x170	PERROT	19503	MNG95030	MXM95030
130 E 18, 130 E 18 K	01.94-	AR	360x170	PERROT	19503	MNG95030	MXM95030
130 E 23	09.00-	AR	360x170	PERROT	19503	MNG95030	MXM95030
130 E 24 tector, 130 E 24 K tector	09.00-	AR	360x170	PERROT	19503	MNG95030	MXM95030
130 E 28 tector, 130 E 28 K tector	09.00-	AR	360x170	PERROT	19503	MNG95030	MXM95030
135 E 18 W, 135 E 18 WR	09.00-	AR	360x170	PERROT	19503	MNG95030	MXM95030
135 E 23 W, 135 E 23 WR	09.00-	AR	360x170	PERROT	19503	MNG95030	MXM95030
140 E 18 W tector	09.00-	AR	360x170	PERROT	19503	MNG95030	MXM95030
140 E 21 W tector	09.00-	AR	360x170	PERROT	19503	MNG95030	MXM95030
150 E 18 tector, 150 E 18 K tector	09.00-	AR	360x170	PERROT	19503	MNG95030	MXM95030
150 E 24 tector, 150 E 24 K tector	09.00-	AR	360x170	PERROT	19503	MNG95030	MXM95030
150 E 28 tector, 150 E 28 K tector	09.00-	AR	360x170	PERROT	19503	MNG95030	MXM95030
170 E 18, 170 E 18 K	09.00-	AR	360x170	PERROT	19503	MNG95030	MXM95030
170 E 23, 170 E 23 K	09.00-	AR	360x170	PERROT	19503	MNG95030	MXM95030
170 E 27	09.00-	AR	360x170	PERROT	19503	MNG95030	MXM95030

APPLICATION PAR MODELES

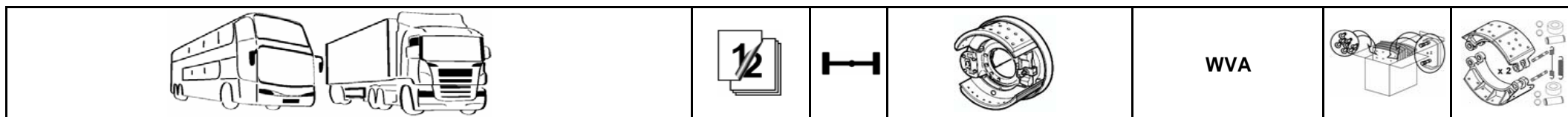

IVECO ../..								
EUROCARGO ../..								
180 E 18, 180 E 18 K	09.00-	AR	360x170	PERROT	19503		MNG95030	MXM95030
180 E 23, 180 E 23 K	09.00-	AR	360x170	PERROT	19503		MNG95030	MXM95030
180 E 27	09.00-	AR	360x170	PERROT	19503		MNG95030	MXM95030
260 E 23 T	01.92-	AR	360x170	PERROT	19503		MNG95030	MXM95030
280 E 23 T	01.92-	AR	360x170	PERROT	19503		MNG95030	MXM95030
320 E 27 T	01.92-	AR	360x170	PERROT	19503		MNG95030	MXM95030
EUROSTAR								
LD 190 E 38 P	01.93-04.96	AR	410x200	ROCKWELL 1	19554/19553		MNG95540	MXM95540
LD 190 E 38 P	01.93-04.96	AR	410x180	ROCKWELL 1	19555/19556		MNG95550	MXM95550
LD 190 E 38 P (Ch.n°: <4206700)	05.96-08.98	AR	410x180	ROCKWELL 2	19714/19715/19556		MNG97140	MXM97140
LD 190 E 38 P (Ch.n°: <4206700)	05.96-08.98	AR	410x200	ROCKWELL 2	19716/19717/19553		MNG97160	MXM97160
LD 190 E 38 P (Ch.n°: <63808)	09.98-05.99	AR	410x200	PERROT 1	19343/19263			MXM90910
LD 190 E 38 P (Ch.n°: 63809>)	05.99-02.02	AR	410x182	PERROT 2	19099/19100		MNG90990	MXM90990
LD 190 E 38 P (Ch.n°: 63809>)	05.99-02.02	AR	410x202	PERROT 2	19091/19098		MNG90910	MXM90910
LD 190 E 39 P, LD 190 E 40 (Ch.n°: 63809>)	11.99-02.02	AR	410x182	PERROT 2	19099/19100		MNG90990	MXM90990
LD 190 E 39 P, LD 190 E 40 (Ch.n°: 63809>)	11.99-02.02	AR	410x202	PERROT 2	19091/19098		MNG90910	MXM90910
LD 190 E 42	01.93-04.96	AR	410x200	ROCKWELL 1	19554/19553		MNG95540	MXM95540
LD 190 E 42	01.93-04.96	AR	410x180	ROCKWELL 1	19555/19556		MNG95550	MXM95550
LD 190 E 42 (Ch.n°: <4206700)	05.96-08.98	AR	410x180	ROCKWELL 2	19714/19715/19556		MNG97140	MXM97140
LD 190 E 42 (Ch.n°: <4206700)	05.96-08.98	AR	410x200	ROCKWELL 2	19716/19717/19553		MNG97160	MXM97160
LD 190 E 42 (Ch.n°: <63808)	09.98-05.99	AR	410x200	PERROT 1	19343/19263			MXM90910
LD 190 E 42, LD 190 E 43 P (Ch.n°: 63809>)	05.99-02.02	AR	410x182	PERROT 2	19099/19100		MNG90990	MXM90990
LD 190 E 42, LD 190 E 43 P (Ch.n°: 63809>)	05.99-02.02	AR	410x202	PERROT 2	19091/19098		MNG90910	MXM90910
LD 190 E 47, LD 190 E 52	01.93-04.96	AR	410x200	ROCKWELL 1	19554/19553		MNG95540	MXM95540
LD 190 E 47, LD 190 E 52	01.93-04.96	AR	410x180	ROCKWELL 1	19555/19556		MNG95550	MXM95550
LD 190 E 47, LD 190 E 52 (Ch.n°: <4206700)	05.96-08.98	AR	410x180	ROCKWELL 2	19714/19715/19556		MNG97140	MXM97140
LD 190 E 47, LD 190 E 52 (Ch.n°: <4206700)	05.96-08.98	AR	410x200	ROCKWELL 2	19716/19717/19553		MNG97160	MXM97160
LD 190 E 47, LD 190 E 52 (Ch.n°: <63808)	09.98-05.99	AR	410x200	PERROT 1	19343/19263			MXM90910
LD 190 E 47, LD 190 E 52 (Ch.n°: 63809>)	05.99-02.02	AR	410x182	PERROT 2	19099/19100		MNG90990	MXM90990
LD 190 E 47, LD 190 E 52 (Ch.n°: 63809>)	05.99-02.02	AR	410x202	PERROT 2	19091/19098		MNG90910	MXM90910
LD 240 E 38, LD 240 E 42	01.93-04.96	AR	410x200	ROCKWELL 1	19554/19553		MNG95540	MXM95540
LD 240 E 38, LD 240 E 42	01.93-04.96	AR	410x180	ROCKWELL 1	19555/19556		MNG95550	MXM95550
LD 240 E 38, LD 240 E 42 (Ch.n°: <4206700)	05.96-08.98	AR	410x180	ROCKWELL 2	19714/19715/19556		MNG97140	MXM97140
LD 240 E 38, LD 240 E 42 (Ch.n°: <4206700)	05.96-08.98	AR	410x200	ROCKWELL 2	19716/19717/19553		MNG97160	MXM97160
LD 240 E 38, LD 240 E 42 (Ch.n°: <63808)	09.98-05.99	AR	410x200	PERROT 1	19343/19263			MXM90910
LD 240 E 38, LD 240 E 42 (Ch.n°: 63809>)	05.99-02.02	AR	410x182	PERROT 2	19099/19100		MNG90990	MXM90990

APPLICATION PAR MODELES

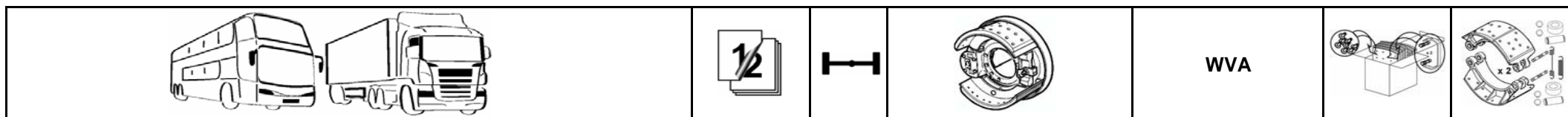

IVECO/ EUROSTAR/								
LD 240 E 38, LD 240 E 42 (Ch.n°: 63809>)	05.99-02.02	AR	410x202	PERROT 2	19091/19098	MNG90910	MXM90910	
LD 240 E 47 P, LD 240 E 52 P	01.93-04.96	AR	410x200	ROCKWELL 1	19554/19553	MNG95540	MXM95540	
LD 240 E 47 P, LD 240 E 52 P	01.93-04.96	AR	410x180	ROCKWELL 1	19555/19556	MNG95550	MXM95550	
LD 240 E 47 P, LD 240 E 52 P (Ch.n°: <4206700)	05.96-08.98	AR	410x180	ROCKWELL 2	19714/19715/19556	MNG97140	MXM97140	
LD 240 E 47 P, LD 240 E 52 P (Ch.n°: <4206700)	05.96-08.98	AR	410x200	ROCKWELL 2	19716/19717/19553	MNG97160	MXM97160	
LD 240 E 47 P, LD 240 E 52 P (Ch.n°: <63808)	09.98-05.99	AR	410x200	PERROT 1	19343/19263		MXM90910	
LD 240 E 47 P, LD 240 E 52 P (Ch.n°: 63809>)	05.99-02.02	AR	410x182	PERROT 2	19099/19100	MNG90990	MXM90990	
LD 240 E 47 P, LD 240 E 52 P (Ch.n°: 63809>)	05.99-02.02	AR	410x202	PERROT 2	19091/19098	MNG90910	MXM90910	
LD 260 E 38 P	01.93-04.96	AR	410x200	ROCKWELL 1	19554/19553	MNG95540	MXM95540	
LD 260 E 38 P	01.93-04.96	AR	410x180	ROCKWELL 1	19555/19556	MNG95550	MXM95550	
LD 260 E 38 P (Ch.n°: <4206700)	05.96-08.98	AR	410x180	ROCKWELL 2	19714/19715/19556	MNG97140	MXM97140	
LD 260 E 38 P (Ch.n°: <4206700)	05.96-08.98	AR	410x200	ROCKWELL 2	19716/19717/19553	MNG97160	MXM97160	
LD 260 E 38 P (Ch.n°: <63808)	09.98-05.99	AR	410x200	PERROT 1	19343/19263		MXM90910	
LD 260 E 38 P, LD 260 E 39 P, LD 260 E 40 (Ch.n°: 63809>)	05.99-02.02	AR	410x182	PERROT 2	19099/19100	MNG90990	MXM90990	
LD 260 E 38 P, LD 260 E 39 P, LD 260 E 40 (Ch.n°: 63809>)	05.99-02.02	AR	410x202	PERROT 2	19091/19098	MNG90910	MXM90910	
LD 260 E 42 P, LD 260 E 43 Y/PS	01.93-04.96	AR	410x200	ROCKWELL 1	19554/19553	MNG95540	MXM95540	
LD 260 E 42 P, LD 260 E 43 Y/PS	01.93-04.96	AR	410x180	ROCKWELL 1	19555/19556	MNG95550	MXM95550	
LD 260 E 42 P, LD 260 E 43 Y/PS (Ch.n°: <4206700)	05.96-08.98	AR	410x180	ROCKWELL 2	19714/19715/19556	MNG97140	MXM97140	
LD 260 E 42 P, LD 260 E 43 Y/PS (Ch.n°: <4206700)	05.96-08.98	AR	410x200	ROCKWELL 2	19716/19717/19553	MNG97160	MXM97160	
LD 260 E 42 P, LD 260 E 43 Y/PS (Ch.n°: <63808)	09.98-05.99	AR	410x200	PERROT 1	19343/19263		MXM90910	
LD 260 E 42 P, LD 260 E 43 Y/PS (Ch.n°: 63809>)	05.99-02.02	AR	410x182	PERROT 2	19099/19100	MNG90990	MXM90990	
LD 260 E 42 P, LD 260 E 43 Y/PS (Ch.n°: 63809>)	05.99-02.02	AR	410x202	PERROT 2	19091/19098	MNG90910	MXM90910	
LD 260 E 47, LD 260 E 52	01.93-04.96	AR	410x200	ROCKWELL 1	19554/19553	MNG95540	MXM95540	
LD 260 E 47, LD 260 E 52	01.93-04.96	AR	410x180	ROCKWELL 1	19555/19556	MNG95550	MXM95550	
LD 260 E 47, LD 260 E 52 (Ch.n°: <4206700)	05.96-08.98	AR	410x180	ROCKWELL 2	19714/19715/19556	MNG97140	MXM97140	
LD 260 E 47, LD 260 E 52 (Ch.n°: <4206700)	05.96-08.98	AR	410x200	ROCKWELL 2	19716/19717/19553	MNG97160	MXM97160	
LD 260 E 47, LD 260 E 52 (Ch.n°: <63808)	09.98-05.99	AR	410x200	PERROT 1	19343/19263		MXM90910	
LD 260 E 47, LD 260 E 52 (Ch.n°: 63809>)	05.99-02.02	AR	410x182	PERROT 2	19099/19100	MNG90990	MXM90990	
LD 260 E 47, LD 260 E 52 (Ch.n°: 63809>)	05.99-02.02	AR	410x202	PERROT 2	19091/19098	MNG90910	MXM90910	
LD 400 E 38 TXP, LD 400 E 42 TXP	01.93-04.96	AR	410x200	ROCKWELL 1	19554/19553	MNG95540	MXM95540	
LD 400 E 38 TXP, LD 400 E 42 TXP	01.93-04.96	AR	410x180	ROCKWELL 1	19555/19556	MNG95550	MXM95550	
LD 400 E 38 TXP, LD 400 E 42 TXP (Ch.n°: <4206700)	05.96-08.98	AR	410x180	ROCKWELL 2	19714/19715/19556	MNG97140	MXM97140	
LD 400 E 38 TXP, LD 400 E 42 TXP (Ch.n°: <4206700)	05.96-08.98	AR	410x200	ROCKWELL 2	19716/19717/19553	MNG97160	MXM97160	
LD 400 E 38 TXP, LD 400 E 42 TXP (Ch.n°: <63808)	09.98-05.99	AR	410x200	PERROT 1	19343/19263		MXM90910	
LD 400 E 38 TXP, LD 400 E 42 TXP (Ch.n°: 63809>)	05.99-02.02	AR	410x182	PERROT 2	19099/19100	MNG90990	MXM90990	
LD 400 E 38 TXP, LD 400 E 42 TXP (Ch.n°: 63809>)	05.99-02.02	AR	410x202	PERROT 2	19091/19098	MNG90910	MXM90910	

APPLICATION PAR MODELES

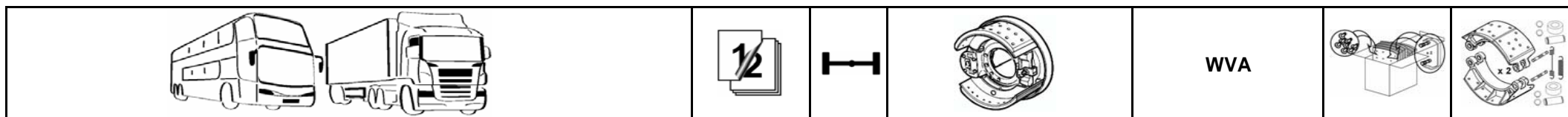

IVECO ../.. EUROSTAR ../..								
LD 440 E 38 T, LD 440 E 38 TXP	01.93-04.96	AR	410x200	ROCKWELL 1	19554/19553		MNG95540	MXM95540
LD 440 E 38 T, LD 440 E 38 TXP	01.93-04.96	AR	410x180	ROCKWELL 1	19555/19556		MNG95550	MXM95550
LD 440 E 38 T, LD 440 E 38 TXP (Ch.n°: <4206700)	05.96-08.98	AR	410x180	ROCKWELL 2	19714/19715/19556		MNG97140	MXM97140
LD 440 E 38 T, LD 440 E 38 TXP (Ch.n°: <4206700)	05.96-08.98	AR	410x200	ROCKWELL 2	19716/19717/19553		MNG97160	MXM97160
LD 440 E 38 T, LD 440 E 38 TXP (Ch.n°: <63808)	09.98-05.99	AR	410x200	PERROT 1	19343/19263			MXM90910
LD 440 E 38 TZ, LD 440 E 42 T	01.93-04.96	AR	410x200	ROCKWELL 1	19554/19553		MNG95540	MXM95540
LD 440 E 38 TZ, LD 440 E 42 T	01.93-04.96	AR	410x180	ROCKWELL 1	19555/19556		MNG95550	MXM95550
LD 440 E 38 TZ, LD 440 E 42 T (Ch.n°: <4206700)	05.96-08.98	AR	410x180	ROCKWELL 2	19714/19715/19556		MNG97140	MXM97140
LD 440 E 38 TZ, LD 440 E 42 T (Ch.n°: <4206700)	05.96-08.98	AR	410x200	ROCKWELL 2	19716/19717/19553		MNG97160	MXM97160
LD 440 E 38 TZ, LD 440 E 42 T (Ch.n°: <63808)	09.98-05.99	AR	410x200	PERROT 1	19343/19263			MXM90910
LD 440 E 38 TZ, LD 440 E 42 T (Ch.n°: 63809>)	05.99-02.02	AR	410x182	PERROT 2	19099/19100		MNG90990	MXM90990
LD 440 E 38 TZ, LD 440 E 42 T (Ch.n°: 63809>)	05.99-02.02	AR	410x202	PERROT 2	19091/19098		MNG90910	MXM90910
LD 440 E 39 T, LD 440 E 40 T (Ch.n°: 63809>)	11.99-02.02	AR	410x182	PERROT 2	19099/19100		MNG90990	MXM90990
LD 440 E 39 T, LD 440 E 40 T (Ch.n°: 63809>)	11.99-02.02	AR	410x202	PERROT 2	19091/19098		MNG90910	MXM90910
LD 440 E 42 TXP, LD 440 E 42 TZ	01.93-04.96	AR	410x200	ROCKWELL 1	19554/19553		MNG95540	MXM95540
LD 440 E 42 TXP, LD 440 E 42 TZ	01.93-04.96	AR	410x180	ROCKWELL 1	19555/19556		MNG95550	MXM95550
LD 440 E 42 TXP, LD 440 E 42 TZ (Ch.n°: <4206700)	05.96-08.98	AR	410x180	ROCKWELL 2	19714/19715/19556		MNG97140	MXM97140
LD 440 E 42 TXP, LD 440 E 42 TZ (Ch.n°: <4206700)	05.96-08.98	AR	410x200	ROCKWELL 2	19716/19717/19553		MNG97160	MXM97160
LD 440 E 42 TXP, LD 440 E 42 TZ (Ch.n°: <63808)	09.98-05.99	AR	410x200	PERROT 1	19343/19263			MXM90910
LD 440 E 42 TXP, LD 440 E 42 TZ (Ch.n°: 63809>)	05.99-02.02	AR	410x182	PERROT 2	19099/19100		MNG90990	MXM90990
LD 440 E 42 TXP, LD 440 E 42 TZ (Ch.n°: 63809>)	05.99-02.02	AR	410x202	PERROT 2	19091/19098		MNG90910	MXM90910
LD 440 E 43 TP, LD 440 E 47 T, LD 440 E 47 TZ	01.93-04.96	AR	410x200	ROCKWELL 1	19554/19553		MNG95540	MXM95540
LD 440 E 43 TP, LD 440 E 47 T, LD 440 E 47 TZ	01.93-04.96	AR	410x180	ROCKWELL 1	19555/19556		MNG95550	MXM95550
LD 440 E 43 TP, LD 440 E 47 T, LD 440 E 47 TZ (Ch.n°: <4206700)	05.96-08.98	AR	410x180	ROCKWELL 2	19714/19715/19556		MNG97140	MXM97140
LD 440 E 43 TP, LD 440 E 47 T, LD 440 E 47 TZ (Ch.n°: <4206700)	05.96-08.98	AR	410x200	ROCKWELL 2	19716/19717/19553		MNG97160	MXM97160
LD 440 E 43 TP, LD 440 E 47 T, LD 440 E 47 TZ (Ch.n°: <63808)	09.98-05.99	AR	410x200	PERROT 1	19343/19263			MXM90910
LD 440 E 43 TP, LD 440 E 47 T, LD 440 E 47 TZ (Ch.n°: 63809>)	05.99-02.02	AR	410x182	PERROT 2	19099/19100		MNG90990	MXM90990
LD 440 E 43 TP, LD 440 E 47 T, LD 440 E 47 TZ (Ch.n°: 63809>)	05.99-02.02	AR	410x202	PERROT 2	19091/19098		MNG90910	MXM90910
LD 440 E 43 TX/P, LD 440 E 48 (Ch.n°: 63809>)	11.99-02.02	AR	410x182	PERROT 2	19099/19100		MNG90990	MXM90990
LD 440 E 43 TX/P, LD 440 E 48 (Ch.n°: 63809>)	11.99-02.02	AR	410x202	PERROT 2	19091/19098		MNG90910	MXM90910
LD 440 E 52 T, LD 440 E 52 TZ	01.93-04.96	AR	410x200	ROCKWELL 1	19554/19553		MNG95540	MXM95540
LD 440 E 52 T, LD 440 E 52 TZ	01.93-04.96	AR	410x180	ROCKWELL 1	19555/19556		MNG95550	MXM95550
LD 440 E 52 T, LD 440 E 52 TZ (Ch.n°: <4206700)	05.96-08.98	AR	410x180	ROCKWELL 2	19714/19715/19556		MNG97140	MXM97140
LD 440 E 52 T, LD 440 E 52 TZ (Ch.n°: <4206700)	05.96-08.98	AR	410x200	ROCKWELL 2	19716/19717/19553		MNG97160	MXM97160
LD 440 E 52 T, LD 440 E 52 TZ (Ch.n°: <63808)	09.98-05.99	AR	410x200	PERROT 1	19343/19263			MXM90910
LD 440 E 52 T, LD 440 E 52 TZ (Ch.n°: 63809>)	05.99-02.02	AR	410x182	PERROT 2	19099/19100		MNG90990	MXM90990

APPLICATION PAR MODELES

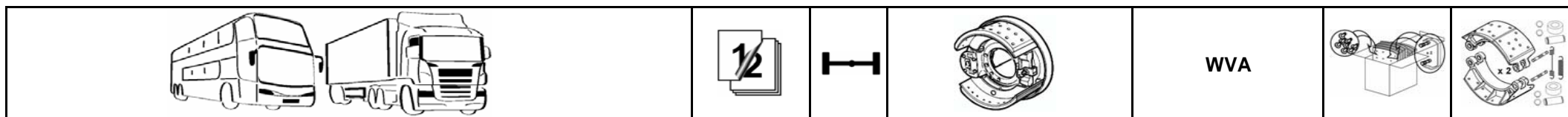

IVECO ../..								
EUROSTAR ../..								
LD 440 E 52 T, LD 440 E 52 TZ (Ch.n°: 63809>)	05.99-02.02	AR	410x202	PERROT 2	19091/19098		MNG90910	MXM90910
LD 440 E, LD 440 E 38 T, LD 440 E 38 TXP (Ch.n°: 63809>)	05.99-02.02	AR	410x182	PERROT 2	19099/19100		MNG90990	MXM90990
LD 440 E, LD 440 E 38 T, LD 440 E 38 TXP (Ch.n°: 63809>)	05.99-02.02	AR	410x202	PERROT 2	19091/19098		MNG90910	MXM90910
EUROTECH MP								
MP 180 E 34, MP 180 E 38, MP 180 E 42	01.92-12.93	AR	410x200	ROCKWELL 1	19554/19553		MNG95540	MXM95540
MP 180 E 34, MP 180 E 38, MP 180 E 42	01.92-12.93	AR2	410x200	ROCKWELL 1	19554/19553		MNG95540	MXM95540
MP 180 E 34, MP 180 E 38, MP 180 E 42	01.92-12.93	AR	410x180	ROCKWELL 1	19555/19556		MNG95550	MXM95550
MP 190 E 34, MP 190 E 38, MP 190 E 42	01.93-04.96	AR	410x200	ROCKWELL 1	19554/19553		MNG95540	MXM95540
MP 190 E 34, MP 190 E 38, MP 190 E 42	01.93-04.96	AR2	410x200	ROCKWELL 1	19554/19553		MNG95540	MXM95540
MP 190 E 34, MP 190 E 38, MP 190 E 42	01.93-04.96	AR	410x180	ROCKWELL 1	19555/19556		MNG95550	MXM95550
MP 190 E 34, MP 190 E 38, MP 190 E 42 (Ch.n°: <4206700)	05.96-08.98	AR	410x180	ROCKWELL 2	19714/19715/19556		MNG97140	MXM97140
MP 190 E 34, MP 190 E 38, MP 190 E 42 (Ch.n°: <4206700)	05.96-08.98	AR2	410x200	ROCKWELL 2	19716/19717/19553		MNG97160	MXM97160
MP 190 E 34, MP 190 E 38, MP 190 E 42 (Ch.n°: <4206700)	05.96-08.98	AR	410x200	ROCKWELL 2	19716/19717/19553		MNG97160	MXM97160
MP 190 E 34, MP 190 E 38, MP 190 E 42 (Ch.n°: <4215282)	09.98-04.99	AR	410x180	PERROT 1	19342/19262			MXM90990
MP 190 E 34, MP 190 E 38, MP 190 E 42 (Ch.n°: <4215282)	09.98-05.99	AR2	410x200	PERROT 1	19343/19263			MXM90910
MP 190 E 34, MP 190 E 38, MP 190 E 42 (Ch.n°: <4215282)	09.98-05.99	AR	410x200	PERROT 1	19343/19263			MXM90910
MP 190 E 34, MP 190 E 38, MP 190 E 42 (Ch.n°: 4215283>)	05.99-	AR	410x182	PERROT 2	19099/19100		MNG90990	MXM90990
MP 190 E 34, MP 190 E 38, MP 190 E 42 (Ch.n°: 4215283>)	05.99-	AR2	410x202	PERROT 2	19091/19098		MNG90910	MXM90910
MP 190 E 39 FP-CT	11.99-	AR	410x182	PERROT 2	19099/19100		MNG90990	MXM90990
MP 190 E 39 FP-CT	11.99-	AR2	410x202	PERROT 2	19091/19098		MNG90910	MXM90910
MP 240 E 30 PS (Ch.n°: <4206700)	01.97-08.98	AR	410x180	ROCKWELL 2	19714/19715/19556		MNG97140	MXM97140
MP 240 E 30 PS (Ch.n°: <4206700)	01.97-08.98	AR2	410x200	ROCKWELL 2	19716/19717/19553		MNG97160	MXM97160
MP 240 E 30 PS (Ch.n°: <4206700)	01.97-08.98	AR	410x200	ROCKWELL 2	19716/19717/19553		MNG97160	MXM97160
MP 240 E 30 PS (Ch.n°: <4215282)	09.98-04.99	AR	410x180	PERROT 1	19342/19262			MXM90990
MP 240 E 30 PS (Ch.n°: <4215282)	09.98-05.99	AR2	410x200	PERROT 1	19343/19263			MXM90910
MP 240 E 30 PS (Ch.n°: <4215282)	09.98-05.99	AR	410x200	PERROT 1	19343/19263			MXM90910
MP 240 E 30 PS (Ch.n°: 4215283>)	05.99-	AR	410x182	PERROT 2	19099/19100		MNG90990	MXM90990
MP 240 E 30 PS (Ch.n°: 4215283>)	05.99-	AR2	410x202	PERROT 2	19091/19098		MNG90910	MXM90910
MP 240 E 34 (Ch.n°: <4206700)	05.96-12.96	AR	410x180	ROCKWELL 2	19714/19715/19556		MNG97140	MXM97140
MP 240 E 34 (Ch.n°: <4206700)	05.96-12.96	AR2	410x200	ROCKWELL 2	19716/19717/19553		MNG97160	MXM97160
MP 240 E 34 (Ch.n°: <4206700)	05.96-12.96	AR	410x200	ROCKWELL 2	19716/19717/19553		MNG97160	MXM97160
MP 240 E 34	09.95-12.96	AR	410x200	ROCKWELL 1	19554/19553		MNG95540	MXM95540
MP 240 E 34	09.95-12.96	AR2	410x200	ROCKWELL 1	19554/19553		MNG95540	MXM95540
MP 240 E 34	09.95-12.96	AR	410x180	ROCKWELL 1	19555/19556		MNG95550	MXM95550
MP 240 E 38, MP 240 E 42	01.92-04.96	AR2	410x200	ROCKWELL 1	19554/19553		MNG95540	MXM95540
MP 240 E 38, MP 240 E 42	01.92-04.96	AR	410x200	ROCKWELL 1	19554/19553		MNG95540	MXM95540

APPLICATION PAR MODELES

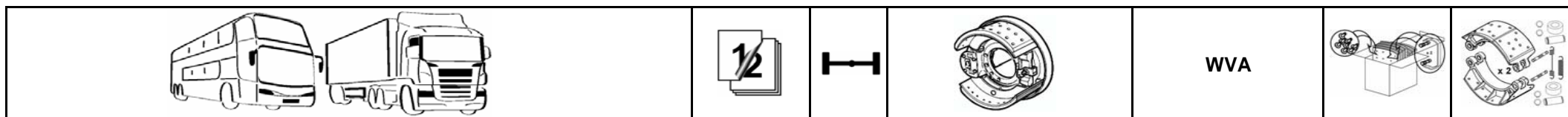

IVECO ../..		EUROTECH MP ../..							
MP 240 E 38, MP 240 E 42	01.92-04.96	AR	410x180	ROCKWELL 1	19555/19556		MNG9550	MXM9550	
MP 240 E 38, MP 240 E 42 (Ch.n°: <4206700)	05.96-08.98	AR	410x180	ROCKWELL 2	19714/19715/19556		MNG97140	MXM97140	
MP 240 E 38, MP 240 E 42 (Ch.n°: <4206700)	05.96-08.98	AR	410x200	ROCKWELL 2	19716/19717/19553		MNG97160	MXM97160	
MP 240 E 38, MP 240 E 42 (Ch.n°: <4215282)	09.98-04.99	AR	410x180	PERROT 1	19342/19262			MXM90990	
MP 240 E 38, MP 240 E 42 (Ch.n°: <4215282)	09.98-05.99	AR2	410x200	PERROT 1	19343/19263			MXM90910	
MP 240 E 38, MP 240 E 42 (Ch.n°: <4215282)	09.98-05.99	AR	410x200	PERROT 1	19343/19263			MXM90910	
MP 240 E 38, MP 240 E 42 (Ch.n°: 4215283>)	05.99-	AR2	410x202	PERROT 2	19091/19098		MNG90910	MXM90910	
MP 240 E 38, MP 240 E 42 (Ch.n°: 4215283>)	05.99-	AR	410x182	PERROT 2	19099/19100		MNG90990	MXM90990	
MP 260 E 38 P, MP 260 E 42	01.94-04.96	AR	410x200	ROCKWELL 1	19554/19553		MNG95540	MXM95540	
MP 260 E 38 P, MP 260 E 42	01.94-04.96	AR2	410x200	ROCKWELL 1	19554/19553		MNG95540	MXM95540	
MP 260 E 38 P, MP 260 E 42	01.94-04.96	AR	410x180	ROCKWELL 1	19555/19556		MNG95550	MXM95550	
MP 260 E 38 P, MP 260 E 42 (Ch.n°: <4206700)	05.96-08.98	AR	410x180	ROCKWELL 2	19714/19715/19556		MNG97140	MXM97140	
MP 260 E 38 P, MP 260 E 42 (Ch.n°: <4206700)	05.96-08.98	AR2	410x200	ROCKWELL 2	19716/19717/19553		MNG97160	MXM97160	
MP 260 E 38 P, MP 260 E 42 (Ch.n°: <4206700)	05.96-08.98	AR	410x200	ROCKWELL 2	19716/19717/19553		MNG97160	MXM97160	
MP 260 E 38 P, MP 260 E 42 (Ch.n°: <4215282)	09.98-04.99	AR	410x180	PERROT 1	19342/19262			MXM90990	
MP 260 E 38 P, MP 260 E 42 (Ch.n°: <4215282)	09.98-05.99	AR2	410x200	PERROT 1	19343/19263			MXM90910	
MP 260 E 38 P, MP 260 E 42 (Ch.n°: <4215282)	09.98-05.99	AR	410x200	PERROT 1	19343/19263			MXM90910	
MP 260 E 38 P, MP 260 E 42 (Ch.n°: 4215283>)	05.99-	AR2	410x202	PERROT 2	19091/19098		MNG90910	MXM90910	
MP 260 E 38 P, MP 260 E 42 (Ch.n°: 4215283>)	05.99-	AR	410x182	PERROT 2	19099/19100		MNG90990	MXM90990	
MP 260 E 39 Y/PS, MP 260 E 43 Y/PS	11.99-	AR2	410x202	PERROT 2	19091/19098		MNG90910	MXM90910	
MP 260 E 39 Y/PS, MP 260 E 43 Y/PS	11.99-	AR	410x182	PERROT 2	19099/19100		MNG90990	MXM90990	
MP 400 E 34 T, MP 400 E 38 T	01.92-04.96	AR	410x200	ROCKWELL 1	19554/19553		MNG95540	MXM95540	
MP 400 E 34 T, MP 400 E 38 T	01.92-04.96	AR2	410x200	ROCKWELL 1	19554/19553		MNG95540	MXM95540	
MP 400 E 34 T, MP 400 E 38 T	01.92-04.96	AR	410x180	ROCKWELL 1	19555/19556		MNG95550	MXM95550	
MP 400 E 34 T, MP 400 E 38 T (Ch.n°: <4206700)	05.96-08.98	AR	410x180	ROCKWELL 2	19714/19715/19556		MNG97140	MXM97140	
MP 400 E 34 T, MP 400 E 38 T (Ch.n°: <4206700)	05.96-08.98	AR	410x200	ROCKWELL 2	19716/19717/19553		MNG97160	MXM97160	
MP 400 E 34 T, MP 400 E 38 T (Ch.n°: <4215282)	09.98-04.99	AR	410x180	PERROT 1	19342/19262			MXM90990	
MP 400 E 34 T, MP 400 E 38 T (Ch.n°: <4215282)	09.98-05.99	AR2	410x200	PERROT 1	19343/19263			MXM90910	
MP 400 E 34 T, MP 400 E 38 T (Ch.n°: <4215282)	09.98-05.99	AR	410x200	PERROT 1	19343/19263			MXM90910	
MP 400 E 34 T, MP 400 E 38 T (Ch.n°: 4215283>)	05.99-	AR	410x182	PERROT 2	19099/19100		MNG90990	MXM90990	
MP 400 E 34 T, MP 400 E 38 T (Ch.n°: 4215283>)	05.99-	AR2	410x202	PERROT 2	19091/19098		MNG90910	MXM90910	
MP 400 E 38 TXP, MP 400 E 42 T	01.92-04.96	AR	410x200	ROCKWELL 1	19554/19553		MNG95540	MXM95540	
MP 400 E 38 TXP, MP 400 E 42 T	01.92-04.96	AR2	410x200	ROCKWELL 1	19554/19553		MNG95540	MXM95540	
MP 400 E 38 TXP, MP 400 E 42 T	01.92-04.96	AR	410x180	ROCKWELL 1	19555/19556		MNG95550	MXM95550	
MP 400 E 38 TXP, MP 400 E 42 T (Ch.n°: <4206700)	05.96-08.98	AR	410x180	ROCKWELL 2	19714/19715/19556		MNG97140	MXM97140	
MP 400 E 38 TXP, MP 400 E 42 T (Ch.n°: <4206700)	05.96-08.98	AR2	410x200	ROCKWELL 2	19716/19717/19553		MNG97160	MXM97160	

APPLICATION PAR MODELES

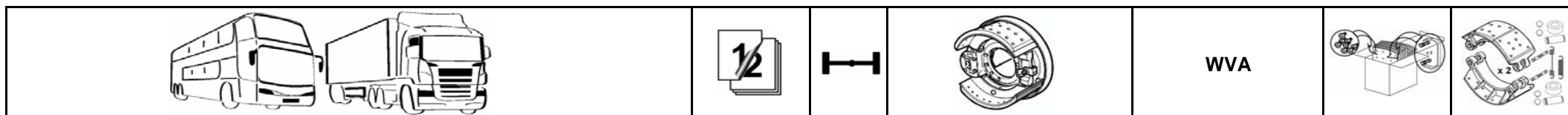

IVECO/ EUROTECH MP/								
MP 400 E 38 TXP, MP 400 E 42 T (Ch.n°: <4206700)	05.96-08.98	AR	410x200	ROCKWELL 2	19716/19717/19553	MNG97160	MXM97160	
MP 400 E 38 TXP, MP 400 E 42 T (Ch.n°: <4215282)	09.98-04.99	AR	410x180	PERROT 1	19342/19262		MXM90990	
MP 400 E 38 TXP, MP 400 E 42 T (Ch.n°: <4215282)	09.98-05.99	AR2	410x200	PERROT 1	19343/19263		MXM90910	
MP 400 E 38 TXP, MP 400 E 42 T (Ch.n°: <4215282)	09.98-05.99	AR	410x200	PERROT 1	19343/19263		MXM90910	
MP 400 E 38 TXP, MP 400 E 42 T (Ch.n°: 4215283>)	05.99-	AR2	410x202	PERROT 2	19091/19098	MNG90910	MXM90910	
MP 400 E 38 TXP, MP 400 E 42 T (Ch.n°: 4215283>)	05.99-	AR	410x182	PERROT 2	19099/19100	MNG90990	MXM90990	
MP 440 E 34 T, MP 440 E 38 T	01.92-04.96	AR2	410x200	ROCKWELL 1	19554/19553	MNG95540	MXM95540	
MP 440 E 34 T, MP 440 E 38 T	01.92-04.96	AR	410x200	ROCKWELL 1	19554/19553	MNG95540	MXM95540	
MP 440 E 34 T, MP 440 E 38 T	01.92-04.96	AR	410x180	ROCKWELL 1	19555/19556	MNG95550	MXM95550	
MP 440 E 34 T, MP 440 E 38 T (Ch.n°: <4206700)	05.96-08.98	AR	410x180	ROCKWELL 2	19714/19715/19556	MNG97140	MXM97140	
MP 440 E 34 T, MP 440 E 38 T (Ch.n°: <4206700)	05.96-08.98	AR	410x200	ROCKWELL 2	19716/19717/19553	MNG97160	MXM97160	
MP 440 E 34 T, MP 440 E 38 T (Ch.n°: <4215282)	09.98-04.99	AR	410x180	PERROT 1	19342/19262		MXM90990	
MP 440 E 34 T, MP 440 E 38 T (Ch.n°: <4215282)	09.98-05.99	AR2	410x200	PERROT 1	19343/19263		MXM90910	
MP 440 E 34 T, MP 440 E 38 T (Ch.n°: <4215282)	09.98-05.99	AR	410x200	PERROT 1	19343/19263		MXM90910	
MP 440 E 34 T, MP 440 E 38 T (Ch.n°: 4215283>)	05.99-	AR2	410x202	PERROT 2	19091/19098	MNG90910	MXM90910	
MP 440 E 34 T, MP 440 E 38 T (Ch.n°: 4215283>)	05.99-	AR	410x182	PERROT 2	19099/19100	MNG90990	MXM90990	
MP 440 E 38 TZ, MP 440 E 42 T, MP 440 E 42 TZ	01.93-04.96	AR	410x200	ROCKWELL 1	19554/19553	MNG95540	MXM95540	
MP 440 E 38 TZ, MP 440 E 42 T, MP 440 E 42 TZ	01.93-04.96	AR2	410x200	ROCKWELL 1	19554/19553	MNG95540	MXM95540	
MP 440 E 38 TZ, MP 440 E 42 T, MP 440 E 42 TZ	01.93-04.96	AR	410x180	ROCKWELL 1	19555/19556	MNG95550	MXM95550	
MP 440 E 38 TZ, MP 440 E 42 T, MP 440 E 42 TZ (Ch.n°: <4206700)	05.96-08.98	AR	410x180	ROCKWELL 2	19714/19715/19556	MNG97140	MXM97140	
MP 440 E 38 TZ, MP 440 E 42 T, MP 440 E 42 TZ (Ch.n°: <4206700)	05.96-08.98	AR2	410x200	ROCKWELL 2	19716/19717/19553	MNG97160	MXM97160	
MP 440 E 38 TZ, MP 440 E 42 T, MP 440 E 42 TZ (Ch.n°: <4206700)	05.96-08.98	AR	410x200	ROCKWELL 2	19716/19717/19553	MNG97160	MXM97160	
MP 440 E 38 TZ, MP 440 E 42 T, MP 440 E 42 TZ (Ch.n°: <4215282)	09.98-04.99	AR	410x180	PERROT 1	19342/19262		MXM90990	
MP 440 E 38 TZ, MP 440 E 42 T, MP 440 E 42 TZ (Ch.n°: <4215282)	09.98-05.99	AR2	410x200	PERROT 1	19343/19263		MXM90910	
MP 440 E 38 TZ, MP 440 E 42 T, MP 440 E 42 TZ (Ch.n°: <4215282)	09.98-05.99	AR	410x200	PERROT 1	19343/19263		MXM90910	
MP 440 E 38 TZ, MP 440 E 42 T, MP 440 E 42 TZ (Ch.n°: 4215283>)	05.99-	AR2	410x202	PERROT 2	19091/19098	MNG90910	MXM90910	
MP 440 E 38 TZ, MP 440 E 42 T, MP 440 E 42 TZ (Ch.n°: 4215283>)	05.99-	AR	410x182	PERROT 2	19099/19100	MNG90990	MXM90990	
MP 440 E 39 TP, MP 440 E 39 TX/P, MP 440 E 43 TP	11.99-	AR2	410x202	PERROT 2	19091/19098	MNG90910	MXM90910	
MP 440 E 39 TP, MP 440 E 39 TX/P, MP 440 E 43 TP	11.99-	AR	410x182	PERROT 2	19099/19100	MNG90990	MXM90990	
EUROTECH MT								
MT 180 E 24, MT 180 E 24 K	01.92-12.96	AR	410x200	ROCKWELL 1	19554/19553	MNG95540	MXM95540	
MT 180 E 24, MT 180 E 24 K	01.92-12.96	AR2	410x200	ROCKWELL 1	19554/19553	MNG95540	MXM95540	
MT 180 E 24, MT 180 E 24 K	01.92-12.96	AR	410x180	ROCKWELL 1	19555/19556	MNG95550	MXM95550	
MT 180 E 24, MT 180 E 24 K (Ch.n°: <4206700)	05.96-12.96	AR	410x180	ROCKWELL 2	19714/19715/19556	MNG97140	MXM97140	
MT 180 E 24, MT 180 E 24 K (Ch.n°: <4206700)	05.96-12.96	AR2	410x200	ROCKWELL 2	19716/19717/19553	MNG97160	MXM97160	
MT 180 E 24, MT 180 E 24 K (Ch.n°: <4206700)	05.96-12.96	AR	410x200	ROCKWELL 2	19716/19717/19553	MNG97160	MXM97160	

APPLICATION PAR MODELES

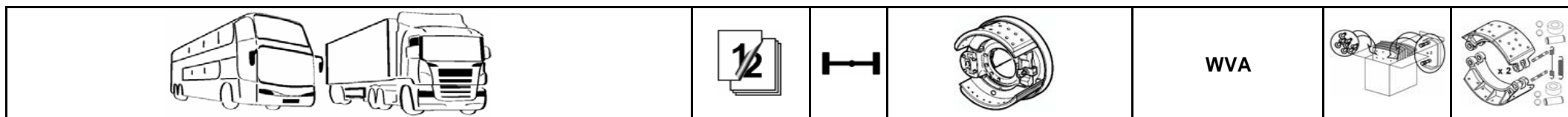

IVECO ../..									
EUROTECH MT ../..									
MT 180 E 27, MT 180 E 27 K	01.92-12.96	AR	410x200	ROCKWELL 1	19554/19553	MNG95540	MXM95540		
MT 180 E 27, MT 180 E 27 K	01.92-12.96	AR2	410x200	ROCKWELL 1	19554/19553	MNG95540	MXM95540		
MT 180 E 27, MT 180 E 27 K	01.92-12.96	AR	410x180	ROCKWELL 1	19555/19556	MNG95550	MXM95550		
MT 180 E 27, MT 180 E 27 K (Ch.n°: <4206700)	05.96-12.96	AR	410x180	ROCKWELL 2	19714/19715/19556	MNG97140	MXM97140		
MT 180 E 27, MT 180 E 27 K (Ch.n°: <4206700)	05.96-12.96	AR2	410x200	ROCKWELL 2	19716/19717/19553	MNG97160	MXM97160		
MT 180 E 27, MT 180 E 27 K (Ch.n°: <4206700)	05.96-12.96	AR	410x200	ROCKWELL 2	19716/19717/19553	MNG97160	MXM97160		
MT 180 E 30 R, MT 180 E 34 R	01.92-12.96	AR	410x200	ROCKWELL 1	19554/19553	MNG95540	MXM95540		
MT 180 E 30 R, MT 180 E 34 R	01.92-12.96	AR2	410x200	ROCKWELL 1	19554/19553	MNG95540	MXM95540		
MT 180 E 30 R, MT 180 E 34 R	01.92-12.96	AR	410x180	ROCKWELL 1	19555/19556	MNG95550	MXM95550		
MT 180 E 30 R (Ch.n°: <4206700)	05.96-12.96	AR	410x180	ROCKWELL 2	19714/19715/19556	MNG97140	MXM97140		
MT 180 E 30 R (Ch.n°: <4206700)	05.96-12.96	AR2	410x200	ROCKWELL 2	19716/19717/19553	MNG97160	MXM97160		
MT 180 E 30 R (Ch.n°: <4206700)	05.96-12.96	AR	410x200	ROCKWELL 2	19716/19717/19553	MNG97160	MXM97160		
MT 190 E 24, MT 190 E 24 K (Ch.n°: <4206700)	01.97-08.98	AR	410x180	ROCKWELL 2	19714/19715/19556	MNG97140	MXM97140		
MT 190 E 24, MT 190 E 24 K (Ch.n°: <4206700)	05.96-08.98	AR2	410x200	ROCKWELL 2	19716/19717/19553	MNG97160	MXM97160		
MT 190 E 24, MT 190 E 24 K (Ch.n°: <4206700)	05.96-08.98	AR	410x200	ROCKWELL 2	19716/19717/19553	MNG97160	MXM97160		
MT 190 E 27, MT 190 E 27 K (Ch.n°: <4206700)	01.97-08.98	AR	410x180	ROCKWELL 2	19714/19715/19556	MNG97140	MXM97140		
MT 190 E 27, MT 190 E 27 K (Ch.n°: <4206700)	05.96-08.98	AR2	410x200	ROCKWELL 2	19716/19717/19553	MNG97160	MXM97160		
MT 190 E 27, MT 190 E 27 K (Ch.n°: <4206700)	05.96-08.98	AR	410x200	ROCKWELL 2	19716/19717/19553	MNG97160	MXM97160		
MT 190 E 30, MT 190 E 30 K (Ch.n°: <4206700)	01.97-08.98	AR	410x180	ROCKWELL 2	19714/19715/19556	MNG97140	MXM97140		
MT 190 E 30, MT 190 E 30 K (Ch.n°: <4206700)	05.96-08.98	AR2	410x200	ROCKWELL 2	19716/19717/19553	MNG97160	MXM97160		
MT 190 E 30, MT 190 E 30 K (Ch.n°: <4206700)	05.96-08.98	AR	410x200	ROCKWELL 2	19716/19717/19553	MNG97160	MXM97160		
MT 400 E 30 T, MT 400 E 34 T	01.92-04.96	AR	410x200	ROCKWELL 1	19554/19553	MNG95540	MXM95540		
MT 400 E 30 T, MT 400 E 34 T	01.92-04.96	AR2	410x200	ROCKWELL 1	19554/19553	MNG95540	MXM95540		
MT 400 E 30 T, MT 400 E 34 T	01.92-04.96	AR	410x180	ROCKWELL 1	19555/19556	MNG95550	MXM95550		
MT 400 E 30 T, MT 400 E 34 T (Ch.n°: <4206700)	05.96-08.98	AR	410x180	ROCKWELL 2	19714/19715/19556	MNG97140	MXM97140		
MT 400 E 30 T, MT 400 E 34 T (Ch.n°: <4206700)	05.96-08.98	AR2	410x200	ROCKWELL 2	19716/19717/19553	MNG97160	MXM97160		
MT 400 E 30 T, MT 400 E 34 T (Ch.n°: <4206700)	05.96-08.98	AR	410x200	ROCKWELL 2	19716/19717/19553	MNG97160	MXM97160		
EUROTECH									
190 E 40 /P, 190 E 43	01.01-	AR2	410x202	PERROT 2	19091/19098	MNG90910	MXM90910		
190 E 40 /P, 190 E 43	01.01-	AR	410x182	PERROT 2	19099/19100	MNG90990	MXM90990		
260 E 40 Y/P	01.01-	AR2	410x202	PERROT 2	19091/19098	MNG90910	MXM90910		
260 E 40 Y/P	01.01-	AR	410x182	PERROT 2	19099/19100	MNG90990	MXM90990		
440 E 40 T, 440 E 40 TX/P	09.00-	AR2	410x202	PERROT 2	19091/19098	MNG90910	MXM90910		
440 E 40 T, 440 E 40 TX/P	09.00-	AR	410x182	PERROT 2	19099/19100	MNG90990	MXM90990		

APPLICATION PAR MODELES

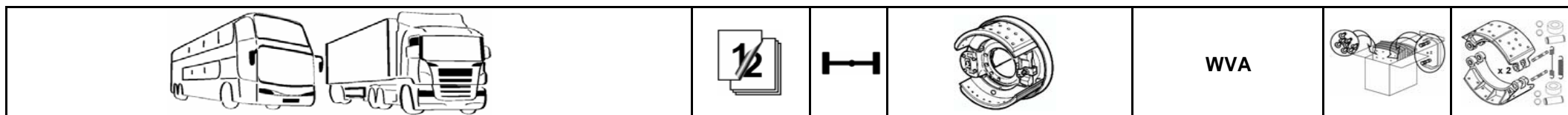

IVECO/ EUROTRAKKER								
MP 190	01.01-03.05	AV	410x200	ROCKWELL 2	19716/19717/19553	MNG97160	MXM97160	
MP 190	01.01-03.05	AR	410x200	ROCKWELL 2	19716/19717/19553	MNG97160	MXM97160	
MP 190 E 30 H, MP 190 E 30 W (Ch.n°: 050897>)	01.93-04.96	AV	410x200	ROCKWELL 1	19554/19553	MNG95540	MXM95540	
MP 190 E 30 H, MP 190 E 30 W (Ch.n°: 050897>)	01.93-04.96	AR	410x200	ROCKWELL 1	19554/19553	MNG95540	MXM95540	
MP 190 E 30 H, MP 190 E 30 W (Ch.n°: <050896)	01.93-06.98	AV	410x200	PERROT 1	19343/19263		MXM90910	
MP 190 E 30 H, MP 190 E 30 W (Ch.n°: <050896)	01.93-06.98	AR	410x200	PERROT 1	19343/19263		MXM90910	
MP 190 E 30 H, MP 190 E 30 W (Ch.n°: 050897>)	05.96-03.05	AV	410x200	ROCKWELL 2	19716/19717/19553	MNG97160	MXM97160	
MP 190 E 30 H, MP 190 E 30 W (Ch.n°: 050897>)	05.96-03.05	AR	410x200	ROCKWELL 2	19716/19717/19553	MNG97160	MXM97160	
MP 190 E 31 H Cursor, MP 190 E 31 W Cursor	09.99-03.05	AV	410x200	ROCKWELL 2	19716/19717/19553	MNG97160	MXM97160	
MP 190 E 31 H Cursor, MP 190 E 31 W Cursor	09.99-03.05	AR	410x200	ROCKWELL 2	19716/19717/19553	MNG97160	MXM97160	
MP 190 E 34 H, MP 190 E 34 W (Ch.n°: 050897>)	01.93-04.96	AV	410x200	ROCKWELL 1	19554/19553	MNG95540	MXM95540	
MP 190 E 34 H, MP 190 E 34 W (Ch.n°: 050897>)	01.93-04.96	AR	410x200	ROCKWELL 1	19554/19553	MNG95540	MXM95540	
MP 190 E 34 H, MP 190 E 34 W (Ch.n°: <050896)	01.93-06.98	AV	410x200	PERROT 1	19343/19263		MXM90910	
MP 190 E 34 H, MP 190 E 34 W (Ch.n°: <050896)	01.93-06.98	AR	410x200	PERROT 1	19343/19263		MXM90910	
MP 190 E 34 H, MP 190 E 34 W (Ch.n°: 050897>)	05.96-03.05	AV	410x200	ROCKWELL 2	19716/19717/19553	MNG97160	MXM97160	
MP 190 E 34 H, MP 190 E 34 W (Ch.n°: 050897>)	05.96-03.05	AR	410x200	ROCKWELL 2	19716/19717/19553	MNG97160	MXM97160	
MP 190 E 35 H Cursor, MP 190 E 35 W Cursor	09.99-03.05	AV	410x200	ROCKWELL 2	19716/19717/19553	MNG97160	MXM97160	
MP 190 E 35 H Cursor, MP 190 E 35 W Cursor	09.99-03.05	AR	410x200	ROCKWELL 2	19716/19717/19553	MNG97160	MXM97160	
MP 190 E 37 H, MP 190 E 37 W (Ch.n°: 050897>)	01.93-04.96	AV	410x200	ROCKWELL 1	19554/19553	MNG95540	MXM95540	
MP 190 E 37 H, MP 190 E 37 W (Ch.n°: 050897>)	01.93-04.96	AR	410x200	ROCKWELL 1	19554/19553	MNG95540	MXM95540	
MP 190 E 37 H, MP 190 E 37 W (Ch.n°: <050896)	01.93-06.98	AV	410x200	PERROT 1	19343/19263		MXM90910	
MP 190 E 37 H, MP 190 E 37 W (Ch.n°: <050896)	01.93-06.98	AR	410x200	PERROT 1	19343/19263		MXM90910	
MP 190 E 37 H, MP 190 E 37 W (Ch.n°: 050897>)	05.96-03.05	AV	410x200	ROCKWELL 2	19716/19717/19553	MNG97160	MXM97160	
MP 190 E 37 H, MP 190 E 37 W (Ch.n°: 050897>)	05.96-03.05	AR	410x200	ROCKWELL 2	19716/19717/19553	MNG97160	MXM97160	
MP 190 E 38 W	01.01-03.05	AV	410x200	ROCKWELL 2	19716/19717/19553	MNG97160	MXM97160	
MP 190 E 38 W	01.01-03.05	AR	410x200	ROCKWELL 2	19716/19717/19553	MNG97160	MXM97160	
MP 190 E 42 H, MP 190 E 42 W (Ch.n°: 050897>)	01.93-04.96	AV	410x200	ROCKWELL 1	19554/19553	MNG95540	MXM95540	
MP 190 E 42 H, MP 190 E 42 W (Ch.n°: 050897>)	01.93-04.96	AR	410x200	ROCKWELL 1	19554/19553	MNG95540	MXM95540	
MP 190 E 42 H, MP 190 E 42 W (Ch.n°: <050896)	01.93-06.98	AV	410x200	PERROT 1	19343/19263		MXM90910	
MP 190 E 42 H, MP 190 E 42 W (Ch.n°: <050896)	01.93-06.98	AR	410x200	PERROT 1	19343/19263		MXM90910	
MP 190 E 42 H, MP 190 E 42 W (Ch.n°: 050897>)	05.96-03.05	AV	410x200	ROCKWELL 2	19716/19717/19553	MNG97160	MXM97160	
MP 190 E 42 H, MP 190 E 42 W (Ch.n°: 050897>)	05.96-03.05	AR	410x200	ROCKWELL 2	19716/19717/19553	MNG97160	MXM97160	
MP 190 E 44 W Cursor, MP 190 E 55 W Cursor	09.00-03.05	AV	410x200	ROCKWELL 2	19716/19717/19553	MNG97160	MXM97160	
MP 190 E 44 W Cursor, MP 190 E 55 W Cursor	09.00-03.05	AR	410x200	ROCKWELL 2	19716/19717/19553	MNG97160	MXM97160	
MP 260 E 30 H (Ch.n°: 050897>)	01.93-04.96	AV	410x200	ROCKWELL 1	19554/19553	MNG95540	MXM95540	
MP 260 E 30 H (Ch.n°: 050897>)	01.93-04.96	AR	410x200	ROCKWELL 1	19554/19553	MNG95540	MXM95540	

APPLICATION PAR MODELES

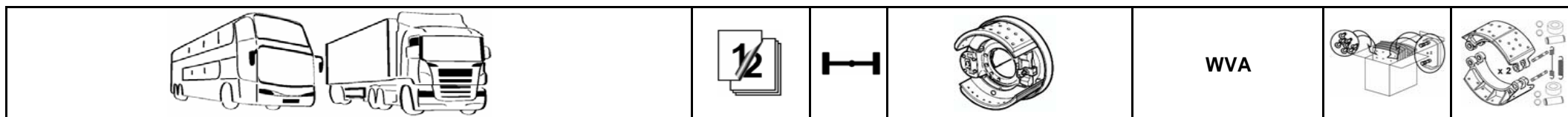

IVECO ../..		EUROTRAKKER ../..							
MP 260 E 30 H (Ch.n°: <050896)	01.93-06.98	AV	410x200	PERROT 1	19343/19263				MXM90910
MP 260 E 30 H (Ch.n°: <050896)	01.93-06.98	AR	410x200	PERROT 1	19343/19263				MXM90910
MP 260 E 30 H (Ch.n°: 050897>)	05.96-03.05	AV	410x200	ROCKWELL 2	19716/19717/19553	MNG97160			MXM97160
MP 260 E 30 H (Ch.n°: 050897>)	05.96-03.05	AR	410x200	ROCKWELL 2	19716/19717/19553	MNG97160			MXM97160
MP 260 E 31 H Cursor, MP 260 E 31 HB Cursor	09.99-03.05	AV	410x200	ROCKWELL 2	19716/19717/19553	MNG97160			MXM97160
MP 260 E 31 H Cursor, MP 260 E 31 HB Cursor	09.99-03.05	AR	410x200	ROCKWELL 2	19716/19717/19553	MNG97160			MXM97160
MP 260 E 34 H, MP 260 E 34 W (Ch.n°: 050897>)	01.93-04.96	AV	410x200	ROCKWELL 1	19554/19553	MNG95540			MXM95540
MP 260 E 34 H, MP 260 E 34 W (Ch.n°: 050897>)	01.93-04.96	AR	410x200	ROCKWELL 1	19554/19553	MNG95540			MXM95540
MP 260 E 34 H, MP 260 E 34 W (Ch.n°: <050896)	01.93-06.98	AV	410x200	PERROT 1	19343/19263				MXM90910
MP 260 E 34 H, MP 260 E 34 W (Ch.n°: <050896)	01.93-06.98	AR	410x200	PERROT 1	19343/19263				MXM90910
MP 260 E 34 H, MP 260 E 34 W (Ch.n°: 050897>)	05.96-03.05	AV	410x200	ROCKWELL 2	19716/19717/19553	MNG97160			MXM97160
MP 260 E 34 H, MP 260 E 34 W (Ch.n°: 050897>)	05.96-03.05	AR	410x200	ROCKWELL 2	19716/19717/19553	MNG97160			MXM97160
MP 260 E 35 H Cursor, MP 260 E 35 W Cursor	09.99-03.05	AV	410x200	ROCKWELL 2	19716/19717/19553	MNG97160			MXM97160
MP 260 E 35 H Cursor, MP 260 E 35 W Cursor	09.99-03.05	AR	410x200	ROCKWELL 2	19716/19717/19553	MNG97160			MXM97160
MP 260 E 37 H, MP 260 E 37 W (Ch.n°: 050897>)	01.93-04.96	AV	410x200	ROCKWELL 1	19554/19553	MNG95540			MXM95540
MP 260 E 37 H, MP 260 E 37 W (Ch.n°: 050897>)	01.93-04.96	AR	410x200	ROCKWELL 1	19554/19553	MNG95540			MXM95540
MP 260 E 37 H, MP 260 E 37 W (Ch.n°: <050896)	01.93-06.98	AV	410x200	PERROT 1	19343/19263				MXM90910
MP 260 E 37 H, MP 260 E 37 W (Ch.n°: <050896)	01.93-06.98	AR	410x200	PERROT 1	19343/19263				MXM90910
MP 260 E 37 H, MP 260 E 37 W (Ch.n°: 050897>)	05.96-03.05	AV	410x200	ROCKWELL 2	19716/19717/19553	MNG97160			MXM97160
MP 260 E 37 H, MP 260 E 37 W (Ch.n°: 050897>)	05.96-03.05	AR	410x200	ROCKWELL 2	19716/19717/19553	MNG97160			MXM97160
MP 260 E 38 H Cursor, MP 260 E 38 W Cursor	01.01-03.05	AV	410x200	ROCKWELL 2	19716/19717/19553	MNG97160			MXM97160
MP 260 E 38 H Cursor, MP 260 E 38 W Cursor	01.01-03.05	AR	410x200	ROCKWELL 2	19716/19717/19553	MNG97160			MXM97160
MP 260 E 42 H, MP 260 E 42 W (Ch.n°: 050897>)	01.93-04.96	AV	410x200	ROCKWELL 1	19554/19553	MNG95540			MXM95540
MP 260 E 42 H, MP 260 E 42 W (Ch.n°: 050897>)	01.93-04.96	AR	410x200	ROCKWELL 1	19554/19553	MNG95540			MXM95540
MP 260 E 42 H, MP 260 E 42 W (Ch.n°: <050896)	01.93-06.98	AV	410x200	PERROT 1	19343/19263				MXM90910
MP 260 E 42 H, MP 260 E 42 W (Ch.n°: <050896)	01.93-06.98	AR	410x200	PERROT 1	19343/19263				MXM90910
MP 260 E 42 H, MP 260 E 42 W (Ch.n°: 050897>)	05.96-03.05	AV	410x200	ROCKWELL 2	19716/19717/19553	MNG97160			MXM97160
MP 260 E 42 H, MP 260 E 42 W (Ch.n°: 050897>)	05.96-03.05	AR	410x200	ROCKWELL 2	19716/19717/19553	MNG97160			MXM97160
MP 260 E 44 H Cursor, MP 260 E 44 W Cursor	01.00-03.05	AV	410x200	ROCKWELL 2	19716/19717/19553	MNG97160			MXM97160
MP 260 E 44 H Cursor, MP 260 E 44 W Cursor	01.00-03.05	AR	410x200	ROCKWELL 2	19716/19717/19553	MNG97160			MXM97160
MP 340 E 34 H, MP 340 E 37 H, MP 340 E 42 H (Ch.n°: 050897>)	01.93-04.96	AV	410x200	ROCKWELL 1	19554/19553	MNG95540			MXM95540
MP 340 E 34 H, MP 340 E 37 H, MP 340 E 42 H (Ch.n°: 050897>)	01.93-04.96	AR	410x200	ROCKWELL 1	19554/19553	MNG95540			MXM95540
MP 340 E 34 H, MP 340 E 37 H, MP 340 E 42 H (Ch.n°: <050896)	01.93-06.98	AV	410x200	PERROT 1	19343/19263				MXM90910
MP 340 E 34 H, MP 340 E 37 H, MP 340 E 42 H (Ch.n°: <050896)	01.93-06.98	AR	410x200	PERROT 1	19343/19263				MXM90910
MP 340 E 34 H, MP 340 E 37 H, MP 340 E 42 H (Ch.n°: 050897>)	05.96-03.05	AV	410x200	ROCKWELL 2	19716/19717/19553	MNG97160			MXM97160
MP 340 E 34 H, MP 340 E 37 H, MP 340 E 42 H (Ch.n°: 050897>)	05.96-03.05	AR	410x200	ROCKWELL 2	19716/19717/19553	MNG97160			MXM97160

APPLICATION PAR MODELES

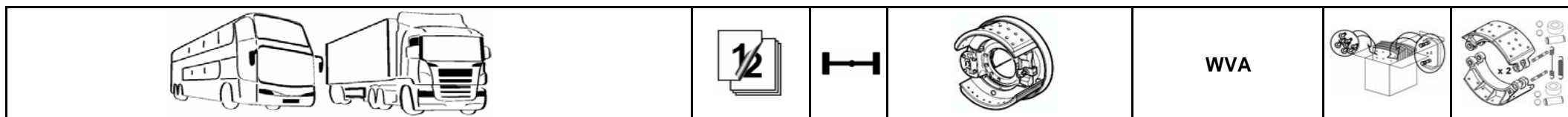

IVECO ../..		EUROTRAKKER ../..							
MP 340 E 35 H Cursor, MP 340 E 35 HB Cursor	09.99-03.05	AV	410x200	ROCKWELL 2	19716/19717/19553	MNG97160	MXM97160		
MP 340 E 35 H Cursor, MP 340 E 35 HB Cursor	09.99-03.05	AR	410x200	ROCKWELL 2	19716/19717/19553	MNG97160	MXM97160		
MP 340 E 38 H Cursor, MP 340 E 38 HB Cursor	01.01-03.05	AV	410x200	ROCKWELL 2	19716/19717/19553	MNG97160	MXM97160		
MP 340 E 38 H Cursor, MP 340 E 38 HB Cursor	01.01-03.05	AR	410x200	ROCKWELL 2	19716/19717/19553	MNG97160	MXM97160		
MP 340 E 44 Cursor, MP 340 E 44 H Cursor, MP 340 E 44 HB Cursor	01.01-03.05	AV	410x200	ROCKWELL 2	19716/19717/19553	MNG97160	MXM97160		
MP 340 E 44 Cursor, MP 340 E 44 H Cursor, MP 340 E 44 HB Cursor	01.01-03.05	AR	410x200	ROCKWELL 2	19716/19717/19553	MNG97160	MXM97160		
MP 380 E 34 H, MP 380 E 37 H, MP 380 E 37 W (Ch.n°: 050897>)	01.93-04.96	AV	410x200	ROCKWELL 1	19554/19553	MNG95540	MXM95540		
MP 380 E 34 H, MP 380 E 37 H, MP 380 E 37 W (Ch.n°: 050897>)	01.93-04.96	AR	410x200	ROCKWELL 1	19554/19553	MNG95540	MXM95540		
MP 380 E 34 H, MP 380 E 37 H, MP 380 E 37 W (Ch.n°: <050896)	01.93-06.98	AV	410x200	PERROT 1	19343/19263		MXM90910		
MP 380 E 34 H, MP 380 E 37 H, MP 380 E 37 W (Ch.n°: <050896)	01.93-06.98	AR	410x200	PERROT 1	19343/19263		MXM90910		
MP 380 E 34 H, MP 380 E 37 H, MP 380 E 37 W (Ch.n°: 050897>)	05.96-03.05	AV	410x200	ROCKWELL 2	19716/19717/19553	MNG97160	MXM97160		
MP 380 E 34 H, MP 380 E 37 H, MP 380 E 37 W (Ch.n°: 050897>)	05.96-03.05	AR	410x200	ROCKWELL 2	19716/19717/19553	MNG97160	MXM97160		
MP 380 E 38 H Cursor, MP 380 E 38 W Cursor	01.01-03.05	AV	410x200	ROCKWELL 2	19716/19717/19553	MNG97160	MXM97160		
MP 380 E 38 H Cursor, MP 380 E 38 W Cursor	01.01-03.05	AR	410x200	ROCKWELL 2	19716/19717/19553	MNG97160	MXM97160		
MP 380 E 42 H, MP 380 E 42 W (Ch.n°: 050897>)	01.93-04.96	AV	410x200	ROCKWELL 1	19554/19553	MNG95540	MXM95540		
MP 380 E 42 H, MP 380 E 42 W (Ch.n°: 050897>)	01.93-04.96	AR	410x200	ROCKWELL 1	19554/19553	MNG95540	MXM95540		
MP 380 E 42 H, MP 380 E 42 W (Ch.n°: <050896)	01.93-06.98	AV	410x200	PERROT 1	19343/19263		MXM90910		
MP 380 E 42 H, MP 380 E 42 W (Ch.n°: <050896)	01.93-06.98	AR	410x200	PERROT 1	19343/19263		MXM90910		
MP 380 E 42 H, MP 380 E 42 W (Ch.n°: 050897>)	05.96-03.05	AV	410x200	ROCKWELL 2	19716/19717/19553	MNG97160	MXM97160		
MP 380 E 42 H, MP 380 E 42 W (Ch.n°: 050897>)	05.96-03.05	AR	410x200	ROCKWELL 2	19716/19717/19553	MNG97160	MXM97160		
MP 380 E 44 H Cursor, MP 380 E 44 W, MP 380 E 44 W Cursor	01.01-03.05	AV	410x200	ROCKWELL 2	19716/19717/19553	MNG97160	MXM97160		
MP 380 E 44 H Cursor, MP 380 E 44 W, MP 380 E 44 W Cursor	01.01-03.05	AR	410x200	ROCKWELL 2	19716/19717/19553	MNG97160	MXM97160		
MP 400 E 34 HT, MP 400 E 37 HT, MP 400 E 37 WT (Ch.n°: 050897>)	01.93-04.96	AV	410x200	ROCKWELL 1	19554/19553	MNG95540	MXM95540		
MP 400 E 34 HT, MP 400 E 37 HT, MP 400 E 37 WT (Ch.n°: 050897>)	01.93-04.96	AR	410x200	ROCKWELL 1	19554/19553	MNG95540	MXM95540		
MP 400 E 34 HT, MP 400 E 37 HT, MP 400 E 37 WT (Ch.n°: <050896)	01.93-06.98	AV	410x200	PERROT 1	19343/19263		MXM90910		
MP 400 E 34 HT, MP 400 E 37 HT, MP 400 E 37 WT (Ch.n°: <050896)	01.93-06.98	AR	410x200	PERROT 1	19343/19263		MXM90910		
MP 400 E 34 HT, MP 400 E 37 HT, MP 400 E 37 WT (Ch.n°: 050897>)	05.96-03.05	AV	410x200	ROCKWELL 2	19716/19717/19553	MNG97160	MXM97160		
MP 400 E 34 HT, MP 400 E 37 HT, MP 400 E 37 WT (Ch.n°: 050897>)	05.96-03.05	AR	410x200	ROCKWELL 2	19716/19717/19553	MNG97160	MXM97160		
MP 400 E 42 HT, MP 400 E 42 WT (Ch.n°: 050897>)	01.93-04.96	AV	410x200	ROCKWELL 1	19554/19553	MNG95540	MXM95540		
MP 400 E 42 HT, MP 400 E 42 WT (Ch.n°: 050897>)	01.93-04.96	AR	410x200	ROCKWELL 1	19554/19553	MNG95540	MXM95540		
MP 400 E 42 HT, MP 400 E 42 WT (Ch.n°: <050896)	01.93-06.98	AV	410x200	PERROT 1	19343/19263		MXM90910		
MP 400 E 42 HT, MP 400 E 42 WT (Ch.n°: <050896)	01.93-06.98	AR	410x200	PERROT 1	19343/19263		MXM90910		
MP 400 E 42 HT, MP 400 E 42 WT (Ch.n°: 050897>)	05.96-03.05	AV	410x200	ROCKWELL 2	19716/19717/19553	MNG97160	MXM97160		
MP 400 E 42 HT, MP 400 E 42 WT (Ch.n°: 050897>)	05.96-03.05	AR	410x200	ROCKWELL 2	19716/19717/19553	MNG97160	MXM97160		
MP 410 E 37 H, MP 410 E 42 H, MP 410 E 42 W (Ch.n°: 050897>)	01.93-04.96	AV	410x200	ROCKWELL 1	19554/19553	MNG95540	MXM95540		
MP 410 E 37 H, MP 410 E 42 H, MP 410 E 42 W (Ch.n°: 050897>)	01.93-04.96	AR	410x200	ROCKWELL 1	19554/19553	MNG95540	MXM95540		

APPLICATION PAR MODELES

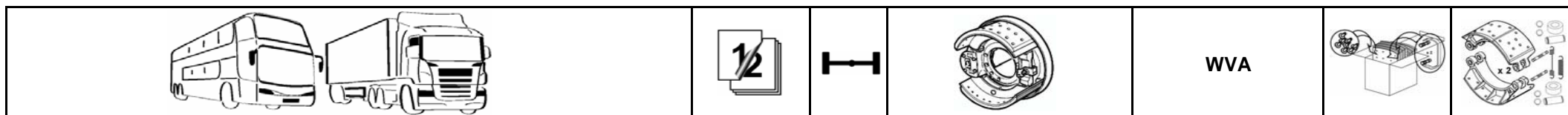

IVECO/..		EUROTRAKKER/..							
MP 410 E 37 H, MP 410 E 42 H, MP 410 E 42 W (Ch.n°: <050896)	01.93-06.98	AV	410x200	PERROT 1	19343/19263				MXM90910
MP 410 E 37 H, MP 410 E 42 H, MP 410 E 42 W (Ch.n°: <050896)	01.93-06.98	AR	410x200	PERROT 1	19343/19263				MXM90910
MP 410 E 37 H, MP 410 E 42 H, MP 410 E 42 W (Ch.n°: 050897>)	05.96-03.05	AV	410x200	ROCKWELL 2	19716/19717/19553		MNG97160		MXM97160
MP 410 E 37 H, MP 410 E 42 H, MP 410 E 42 W (Ch.n°: 050897>)	05.96-03.05	AR	410x200	ROCKWELL 2	19716/19717/19553		MNG97160		MXM97160
MP 410 E 38 H Cursor, MPÜ 410 E 38 H Cursor, MP 410 E 44 H Cursor	01.01-03.05	AV	410x200	ROCKWELL 2	19716/19717/19553		MNG97160		MXM97160
MP 410 E 38 H Cursor, MPÜ 410 E 38 H Cursor, MP 410 E 44 H Cursor	01.01-03.05	AR	410x200	ROCKWELL 2	19716/19717/19553		MNG97160		MXM97160
MP 440 E 34 HT, MP 440 E 37 HT, MP 440 E 42 HT (Ch.n°: 050897>)	01.93-04.96	AV	410x200	ROCKWELL 1	19554/19553		MNG95540		MXM95540
MP 440 E 34 HT, MP 440 E 37 HT, MP 440 E 42 HT (Ch.n°: 050897>)	01.93-04.96	AR	410x200	ROCKWELL 1	19554/19553		MNG95540		MXM95540
MP 440 E 34 HT, MP 440 E 37 HT, MP 440 E 42 HT (Ch.n°: <050896)	01.93-06.98	AV	410x200	PERROT 1	19343/19263				MXM90910
MP 440 E 34 HT, MP 440 E 37 HT, MP 440 E 42 HT (Ch.n°: <050896)	01.93-06.98	AR	410x200	PERROT 1	19343/19263				MXM90910
MP 440 E 34 HT, MP 440 E 37 HT, MP 440 E 42 HT (Ch.n°: 050897>)	05.96-03.05	AV	410x200	ROCKWELL 2	19716/19717/19553		MNG97160		MXM97160
MP 440 E 34 HT, MP 440 E 37 HT, MP 440 E 42 HT (Ch.n°: 050897>)	05.96-03.05	AR	410x200	ROCKWELL 2	19716/19717/19553		MNG97160		MXM97160
MP 720 E 37 HT, MP 720 E 37 WT (Ch.n°: 050897>)	01.93-04.96	AV	410x200	ROCKWELL 1	19554/19553		MNG95540		MXM95540
MP 720 E 37 HT, MP 720 E 37 WT (Ch.n°: 050897>)	01.93-04.96	AR	410x200	ROCKWELL 1	19554/19553		MNG95540		MXM95540
MP 720 E 37 HT, MP 720 E 37 WT (Ch.n°: <050896)	01.93-06.98	AV	410x200	PERROT 1	19343/19263				MXM90910
MP 720 E 37 HT, MP 720 E 37 WT (Ch.n°: <050896)	01.93-06.98	AR	410x200	PERROT 1	19343/19263				MXM90910
MP 720 E 37 HT, MP 720 E 37 WT (Ch.n°: 050897>)	05.96-03.05	AV	410x200	ROCKWELL 2	19716/19717/19553		MNG97160		MXM97160
MP 720 E 37 HT, MP 720 E 37 WT (Ch.n°: 050897>)	05.96-03.05	AR	410x200	ROCKWELL 2	19716/19717/19553		MNG97160		MXM97160
MP 720 E 42 HT, MP 720 E 42 WT (Ch.n°: 050897>)	01.93-04.96	AV	410x200	ROCKWELL 1	19554/19553		MNG95540		MXM95540
MP 720 E 42 HT, MP 720 E 42 WT (Ch.n°: 050897>)	01.93-04.96	AR	410x200	ROCKWELL 1	19554/19553		MNG95540		MXM95540
MP 720 E 42 HT, MP 720 E 42 WT (Ch.n°: <050896)	01.93-06.98	AV	410x200	PERROT 1	19343/19263				MXM90910
MP 720 E 42 HT, MP 720 E 42 WT (Ch.n°: <050896)	01.93-06.98	AR	410x200	PERROT 1	19343/19263				MXM90910
MP 720 E 42 HT, MP 720 E 42 WT (Ch.n°: 050897>)	05.96-03.05	AV	410x200	ROCKWELL 2	19716/19717/19553		MNG97160		MXM97160
MP 720 E 42 HT, MP 720 E 42 WT (Ch.n°: 050897>)	05.96-03.05	AR	410x200	ROCKWELL 2	19716/19717/19553		MNG97160		MXM97160
MP 720 E 47 HT (Ch.n°: 050897>)	01.93-04.96	AV	410x200	ROCKWELL 1	19554/19553		MNG95540		MXM95540
MP 720 E 47 HT (Ch.n°: 050897>)	01.93-04.96	AR	410x200	ROCKWELL 1	19554/19553		MNG95540		MXM95540
MP 720 E 47 HT (Ch.n°: <050896)	01.93-06.98	AV	410x200	PERROT 1	19343/19263				MXM90910
MP 720 E 47 HT (Ch.n°: <050896)	01.93-06.98	AR	410x200	PERROT 1	19343/19263				MXM90910
MP 720 E 47 HT (Ch.n°: 050897>)	05.96-03.05	AV	410x200	ROCKWELL 2	19716/19717/19553		MNG97160		MXM97160
MP 720 E 47 HT (Ch.n°: 050897>)	05.96-03.05	AR	410x200	ROCKWELL 2	19716/19717/19553		MNG97160		MXM97160
RENAULT TRUCKS									
SAVIEM									
PX 28, 30, 40		AV	414x150	BENDIX	19049/19199		MNG90490		MXM90490
PX 28, 30, 40		AR2	414x150	BENDIX	19049/19199		MNG90490		MXM90490
SM 21, 170 PE, 260 TPE	-1977	AR	414x150	BENDIX	19049/19199		MNG90490		MXM90490
SM 8	-1978	AR	414x150	BENDIX	19049/19199		MNG90490		MXM90490

APPLICATION PAR MODELES

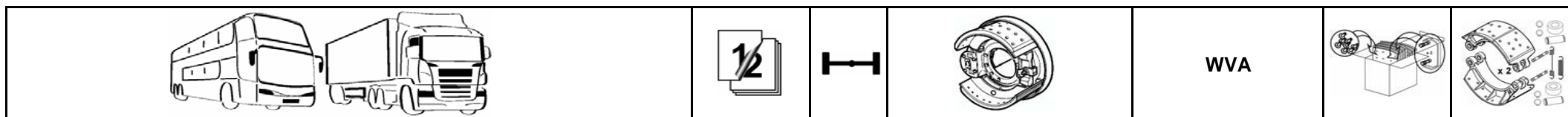

RENAULT TRUCKS ...

BERLIET

950 K, 951 K	-1979	AR	414x150	BENDIX	19049/19199	MNG90490	MXM90490
GB 131, 191, A, 231, A, B		AR	414x150	BENDIX	19049/19199	MNG90490	MXM90490
GBD (4x4), GRH (4x2)	-1978	AV	414x150	BENDIX	19049/19199	MNG90490	MXM90490
GBD (4x4), GRH (4x2)	-1978	AR	414x150	BENDIX	19049/19199	MNG90490	MXM90490
GBH 260, 280 (6x4), GBH 280, Turbo (6x6)		AV	414x150	BENDIX	19049/19199	MNG90490	MXM90490
GC/GF 190, 191, 230, 231		AV	414x150	BENDIX	19049/19199	MNG90490	MXM90490
GC/GF 190, 191, 230, 231		AR	414x150	BENDIX	19049/19199	MNG90490	MXM90490
GL 900		AR	414x150	BENDIX	19049/19199	MNG90490	MXM90490
GLR		AV	414x150	BENDIX	19049/19199	MNG90490	MXM90490
GR 230 (6x4)		AV	414x150	BENDIX	19049/19199	MNG90490	MXM90490
GR 230 (6x4)		AR2	414x150	BENDIX	19049/19199	MNG90490	MXM90490
GR 230 (6x4)		AR	414x150	BENDIX	19049/19199	MNG90490	MXM90490
GR 305 (4x2)		AV	414x150	BENDIX	19049/19199	MNG90490	MXM90490
GR 305 (6x4)		AV	414x150	BENDIX	19049/19199	MNG90490	MXM90490
GR 305 (4x2)		AR	414x150	BENDIX	19049/19199	MNG90490	MXM90490
GRH (6x4)	1978-	AV	414x150	BENDIX	19049/19199	MNG90490	MXM90490
GRH (6x4)	1978-	AR2	414x150	BENDIX	19049/19199	MNG90490	MXM90490
GRH (6x4)	1978-	AR	414x150	BENDIX	19049/19199	MNG90490	MXM90490
HB HF (6x4)		AV	414x150	BENDIX	19049/19199	MNG90490	MXM90490
HB HF (4x2)		AV	414x150	BENDIX	19049/19199	MNG90490	MXM90490
HB HF (6x4)		AR2	414x150	BENDIX	19049/19199	MNG90490	MXM90490
HB HF (4x2)		AR	414x150	BENDIX	19049/19199	MNG90490	MXM90490
TAK 250		AR	414x150	BENDIX	19049/19199	MNG90490	MXM90490
TB 191, 231 (4x2)	1978-	AR	414x150	BENDIX	19049/19199	MNG90490	MXM90490
TBH, TLM 280 (6x4)		AV	414x150	BENDIX	19049/19199	MNG90490	MXM90490
TBH, TLR, TR (4x2)		AV	414x150	BENDIX	19049/19199	MNG90490	MXM90490
TF 230 Turbo	1977-1979	AR	414x150	BENDIX	19049/19199	MNG90490	MXM90490
TRH 320, 350 (6x4)		AV	414x150	BENDIX	19049/19199	MNG90490	MXM90490
TRH 320, 350 (6x4)		AR2	414x150	BENDIX	19049/19199	MNG90490	MXM90490
TRH 320, 350 (6x4)		AR	414x150	BENDIX	19049/19199	MNG90490	MXM90490
RVI							
85.150	1987-	AR	360x170	BENDIX	19255/19259	MNG92550	MXM92550
110.130, 110.170		AR	360x170	BENDIX	19255/19259	MNG92550	MXM92550
110.150 Turbo	-1989	AR	360x170	BENDIX	19255/19259	MNG92550	MXM92550

APPLICATION PAR MODELES

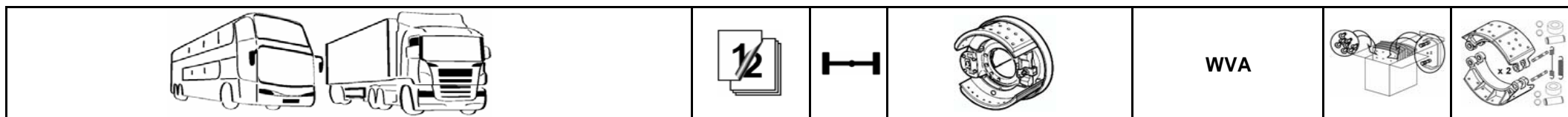

RENAULT TRUCKS ...

MIDLINER M/S

M 120/140/150/160/180 .12/13, PA 160/180	1989-12.94	AR	360x170	BENDIX	19255/19259	MNG92550	MXM92550
M 150.14, 160.14/15 (4x2)	1989-1992	AR	414x150	BENDIX	19049/19199	MNG90490	MXM90490
M 150/180/210/230/250 .12, 13 (4x2)	01.95-	AR	360x170	BENDIX	19255/19259	MNG92550	MXM92550
M 150/180/210/230/250 .12/13 (4x2)	01.95-	AR	360x170	BENDIX	19255/19259	MNG92550	MXM92550
M 180/200/210/230.15/16 (4x2)	1989-03.93	AV	414x150	RT	19934	MNG99340	MXM99340
M 180/200/210/230.15/16 (4x2)	1989-03.93	AR	414x150	RT	19934	MNG99340	MXM99340
M 200.14/15/16 (4x2)	1989-1992	AR	414x150	BENDIX	19049/19199	MNG90490	MXM90490
M 200/210/230 .12/13, PA 160/180	1989-12.94	AR	360x170	BENDIX	19255/19259	MNG92550	MXM92550
M 230.15/16 (4x2)	1989-1992	AR	414x150	BENDIX	19049/19199	MNG90490	MXM90490
M 250.15/16, PA 160/180 (15T-16T) (4x2)	1996-01.01	AV	414x150	RT	19934	MNG99340	MXM99340
M 250.15/16, PA 160/180 (15T-16T) (4x2)	1996-01.01	AR	414x150	RT	19934	MNG99340	MXM99340
M 250.15/16, PA 160/180 (15T-16T) (4x2)	1996-	AR	414x175	RT	19935	MNG99350	MXM99350
S 130.11	05.86-	AR	360x170	BENDIX	19255/19259	MNG92550	MXM92550
S 130.13/14, 150.13 ti/14 ti (4x2)	05.86-	AR	360x170	BENDIX	19255/19259	MNG92550	MXM92550
S 130/150 .13/14 (4x2)	05.86-	AR	360x170	BENDIX	19255/19259	MNG92550	MXM92550
S 150.11ti, 170.11, 13 (4x2)	05.86-	AR	360x170	BENDIX	19255/19259	MNG92550	MXM92550
S 150/170 .11, 13 (4x2)	05.86-	AR	360x170	BENDIX	19255/19259	MNG92550	MXM92550
S 170 SH/14BOM, S220 ti (4x2)	10.83-05.89	AR	414x150	BENDIX	19049/19199	MNG90490	MXM90490
S12, S13 (4x2)	1987-1990	AR	360x170	BENDIX	19255/19259	MNG92550	MXM92550

C - RANGE

C 210, 260, 290, CLR 220	12.83-05.91	AV	414x150	RT	19934	MNG99340	MXM99340
C 210, 260, 290, CLR 220	12.83-05.91	AV	414x150	BENDIX	19049/19199	MNG90490	MXM90490
C 210, 260, 290, CLR 220	12.83-05.91	AR	414x150	RT	19934	MNG99340	MXM99340
C 260.26, C 290.26 (6x4)	1988-10.98	AV	414x150	BENDIX	19049/19199	MNG90490	MXM90490
C 260.26, C 290.26 (6x4)	1988-10.98	AR2	414x150	BENDIX	19049/19199	MNG90490	MXM90490
C 260.26, C 290.26 (6x4)	1988-10.98	AR	414x150	BENDIX	19049/19199	MNG90490	MXM90490
C 300.19, 340ti.19T (4x2)	1988-10.98	AV	414x150	RT	19934	MNG99340	MXM99340
C 300.19, 340ti.19T (4x2)	1988-10.98	AR	414x175	RT	19935	MNG99350	MXM99350
C 300.26 (6x4)	1989-10.98	AV	414x150	RT	19934	MNG99340	MXM99340
C 300.26 (6x4)	1989-10.98	AR2	414x175	RT	19935	MNG99350	MXM99350
C 300.26 (6x4)	1989-10.98	AR	414x175	RT	19935	MNG99350	MXM99350
CBH 280 Turbo (6x4)	1986-1988	AV	414x150	BENDIX	19049/19199	MNG90490	MXM90490
CBH 280 Turbo (6x4)	1986-1988	AR2	414x150	BENDIX	19049/19199	MNG90490	MXM90490
CBH 280, CBH 320 (6x2)	1989-10.98	AV	414x150	RT	19934	MNG99340	MXM99340
CBH 280, CBH 320 (6x2)	1989-10.98	AR2	414x175	RT	19935	MNG99350	MXM99350
CBH 280, CBH 320 (6x2)	1989-10.98	AR	414x175	RT	19935	MNG99350	MXM99350

APPLICATION PAR MODELES

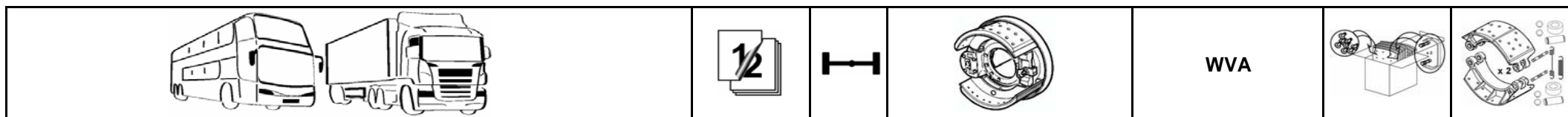

RENAULT TRUCKS ../..

C - RANGE ../..

CBH 320 (6x4)	1989-10.98	AV	414x150	RT	19934	MNG99340	MXM99340
CBH 320 (6x4)	1989-10.98	AV	414x175	RT	19935	MNG99350	MXM99350
CBH 320 (6x4)	1989-10.98	AR2	414x175	RT	19935	MNG99350	MXM99350
CBH 320 (6x4)	1989-10.98	AR	414x175	RT	19935	MNG99350	MXM99350
CBH 340 (4x2)	1986-1988	AV	414x150	BENDIX	19049/19199	MNG90490	MXM90490
CBH 340 (6x2)	1986-1988	AV	414x150	BENDIX	19049/19199	MNG90490	MXM90490
CBH 340 (6x4)	1989-10.98	AV	414x150	RT	19934	MNG99340	MXM99340
CBH 340 (6x4)	1989-10.98	AR2	414x175	RT	19935	MNG99350	MXM99350
CBH 340 (6x4)	1989-10.98	AR	414x175	RT	19935	MNG99350	MXM99350
CBH 385 (6x4)	1989-10.98	AV	414x175	RT	19935	MNG99350	MXM99350
CBH 385 (6x4)	1989-10.98	AR2	414x175	RT	19935	MNG99350	MXM99350
CBH 385 (6x4)	1989-10.98	AR	414x175	RT	19935	MNG99350	MXM99350
CLM 280 T Turbo, CLM 340 T (4x2)	1986-1988	AV	414x150	BENDIX	19049/19199	MNG90490	MXM90490
CLM 320T, 340T, 385T, CBH 340 (4x2)	1988-10.98	AV	414x150	RT	19934	MNG99340	MXM99340
CLM 320T, 340T, 385T, CBH 340 (4x2)	1989-10.98	AR	414x175	RT	19935	MNG99350	MXM99350

G - MANAGER

G 160	05.83-08.91	AV	414x175	RT	19935	MNG99350	MXM99350
G 160	05.83-08.91	AR	414x175	RT	19935	MNG99350	MXM99350
G 170.11 A, 13, 15, 15 A	05.83-02.90	AV	414x150	RT	19934	MNG99340	MXM99340
G 170.11 A, 13, 15, 15 A	05.83-02.90	AR	414x150	RT	19934	MNG99340	MXM99340
G 170.16, 270.17T	-04.83	AV	414x150	BENDIX	19049/19199	MNG90490	MXM90490
G 170.16, 270.17T	05.83-02.90	AV	414x150	RT	19934	MNG99340	MXM99340
G 170.16, 270.17T	05.83-02.90	AR	414x150	RT	19934	MNG99340	MXM99340
G 170.17,17T	05.83-02.90	AV	414x150	RT	19934	MNG99340	MXM99340
G 170.17,17T	05.83-02.90	AR	414x150	RT	19934	MNG99340	MXM99340
G 200	1990-08.91	AV	414x175	RT	19935	MNG99350	MXM99350
G 200	1990-08.91	AR	414x175	RT	19935	MNG99350	MXM99350
G 210.15,.16	11.83-08.91	AV	414x150	RT	19934	MNG99340	MXM99340
G 210.15,.16	11.83-08.91	AR	414x175	RT	19935	MNG99350	MXM99350
G 210.17, 18 Turbo	11.83-02.90	AV	414x150	RT	19934	MNG99340	MXM99340
G 210.17, 18 Turbo	11.83-02.90	AR	414x175	RT	19935	MNG99350	MXM99350
G 210.18	1990-08.91	AV	414x175	RT	19935	MNG99350	MXM99350
G 210.18	1990-08.91	AR	414x175	RT	19935	MNG99350	MXM99350
G 210.19 Turbo, 230/260.19	11.83-02.90	AV	414x150	RT	19934	MNG99340	MXM99340
G 210.19 Turbo, 230/260.19	11.83-02.90	AR	414x150	RT	19934	MNG99340	MXM99340
G 210.19 Turbo, 230/260.19	04.86-08.91	AR	414x175	RT	19935	MNG99350	MXM99350

APPLICATION PAR MODELES

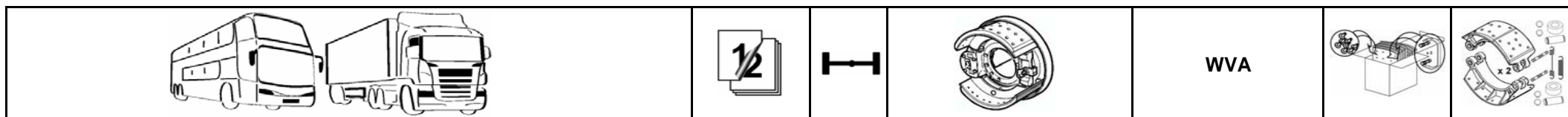

RENAULT TRUCKS ../..

G - MANAGER ../..

G 210.19, 230.19, 260, 260.19, 26	1983-02.86	AV	414x150	BENDIX	19049/19199	MNG90490	MXM90490
G 220.17, 19	11.83-02.90	AV	414x150	RT	19934	MNG99340	MXM99340
G 220.17, 19	11.83-02.90	AR	414x175	RT	19935	MNG99350	MXM99350
G 230 ti	1990-08.91	AV	414x175	RT	19935	MNG99350	MXM99350
G 230 ti	1990-08.91	AR	414x175	RT	19935	MNG99350	MXM99350
G 230.11, 13, 15, 16, 17, SP Turbo	01.85-02.90	AV	414x150	RT	19934	MNG99340	MXM99340
G 230.11, 13, 15, 16, 17, SP Turbo	01.85-02.90	AR	414x150	RT	19934	MNG99340	MXM99340
G 230.17, G 260.16, 17	1983-03.86	AV	414x150	BENDIX	19049/19199	MNG90490	MXM90490
G 260 M 26 Turbo (6x2)	10.82-02.90	AV	414x150	RT	19934	MNG99340	MXM99340
G 260 M 26 Turbo (6x2)	10.82-02.90	AR2	414x150	RT	19934	MNG99340	MXM99340
G 260 M 26 Turbo (6x2)	10.82-02.90	AR	414x175	RT	19935	MNG99350	MXM99350
G 260.15, 17 Turbo, G 320	10.82-02.90	AV	414x150	RT	19934	MNG99340	MXM99340
G 260.15, 17 Turbo, G 320	10.82-02.90	AR	414x150	RT	19934	MNG99340	MXM99340
G 260.16B/C Turbo	10.82-02.90	AV	414x150	RT	19934	MNG99340	MXM99340
G 260.16B/C Turbo	10.82-02.90	AR	414x175	RT	19935	MNG99350	MXM99350
G 260.24/26 Turbo (6x2)	10.82-02.90	AV	414x150	RT	19934	MNG99340	MXM99340
G 260.24/26 Turbo (6x2)	10.82-02.90	AR2	414x150	RT	19934	MNG99340	MXM99340
G 260.24/26 Turbo (6x2)	10.82-02.90	AR	414x150	RT	19934	MNG99340	MXM99340
G 260.24/26 Turbo (6x2)	10.82-02.90	AR	414x175	RT	19935	MNG99350	MXM99350
G 270.15-19	1990-08.91	AV	414x175	RT	19935	MNG99350	MXM99350
G 270.15-19	1990-08.91	AR	414x175	RT	19935	MNG99350	MXM99350
G 270.26 (6x2)	1990-08.91	AV	414x175	RT	19935	MNG99350	MXM99350
G 270.26 (6x2)	1990-08.91	AR2	414x175	RT	19935	MNG99350	MXM99350
G 270.28 (6x2/4)	1990-08.91	AV	414x175	RT	19935	MNG99350	MXM99350
G 270.28 (6x2/4)	1990-08.91	AR2	414x175	RT	19935	MNG99350	MXM99350
G 270.28 (6x2/4)	1990-08.91	AR	414x175	RT	19935	MNG99350	MXM99350
G 280	1990-08.91	AV	414x175	RT	19935	MNG99350	MXM99350
G 280	1990-08.91	AR	414x175	RT	19935	MNG99350	MXM99350
G 290 (6x2/4)	10.82-02.90	AV	414x150	RT	19934	MNG99340	MXM99340
G 290 (6x2/4)	10.82-02.90	AR2	414x150	RT	19934	MNG99340	MXM99340
G 290 (6x2/4)	10.82-02.90	AR2	414x175	RT	19935	MNG99350	MXM99350
G 290 (6x2/4)	10.82-02.90	AR	414x150	RT	19934	MNG99340	MXM99340
G 290 (6x2/4)	10.82-02.90	AR	414x175	RT	19935	MNG99350	MXM99350
G 290.19, A, T, GT	10.82-02.90	AV	414x150	RT	19934	MNG99340	MXM99340
G 290.19, A, T, GT	10.82-02.90	AR	414x150	RT	19934	MNG99340	MXM99340
G 290.19, A, T, GT	10.82-02.90	AR	414x175	RT	19935	MNG99350	MXM99350

APPLICATION PAR MODELES

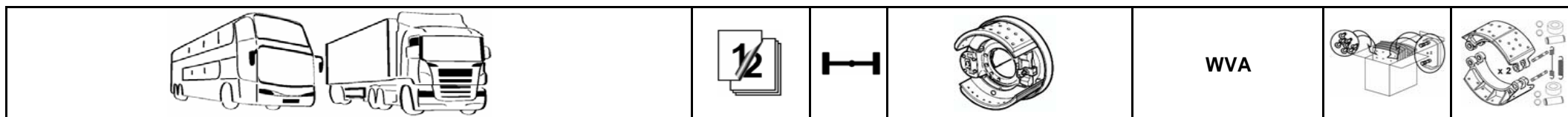

RENAULT TRUCKS ../..

G - MANAGER ../..

G 300	01.90-08.91	AV	414x175	RT	19935	MNG99350	MXM99350
G 300	01.90-08.91	AR	414x175	RT	19935	MNG99350	MXM99350
G 300.19	10.82-02.90	AV	414x150	RT	19934	MNG99340	MXM99340
G 300.19	10.82-02.90	AR	414x175	RT	19935	MNG99350	MXM99350
G 300.26 (6x2)	01.90-08.91	AV	414x175	RT	19935	MNG99350	MXM99350
G 300.26 (6x2)	01.90-08.91	AR2	414x175	RT	19935	MNG99350	MXM99350
G 300.26 (6x4)	01.90-08.91	AV	414x150	RT	19934	MNG99340	MXM99340
G 300.26 (6x4)	01.90-08.91	AR2	414x150	RT	19934	MNG99340	MXM99340
G 300.26 (6x4)	01.90-08.91	AR	414x150	RT	19934	MNG99340	MXM99340
G 300.26 (6x2/4)	01.90-08.91	AV	414x175	RT	19935	MNG99350	MXM99350
G 300.26 (6x2/4)	01.90-08.91	AR2	414x175	RT	19935	MNG99350	MXM99350
G 300.26 (6x2/4)	01.90-08.91	AR	414x175	RT	19935	MNG99350	MXM99350
G 330	01.90-08.91	AV	414x175	RT	19935	MNG99350	MXM99350
G 330	01.90-08.91	AR	414x175	RT	19935	MNG99350	MXM99350
G 330, 340ti (6x2/4)	01.90-08.91	AV	414x175	RT	19935	MNG99350	MXM99350
G 330, 340ti (6x2/4)	01.90-08.91	AR2	414x175	RT	19935	MNG99350	MXM99350
G 330, 340ti (6x4)	01.90-08.91	AV	414x175	RT	19935	MNG99350	MXM99350
G 330, 340ti (6x4)	01.90-08.91	AR2	414x175	RT	19935	MNG99350	MXM99350
G 330, 340ti (6x4)	01.90-08.91	AR	414x175	RT	19935	MNG99350	MXM99350
G 340 ti.32, ti.40 (8x4)	01.90-08.91	AV	414x175	RT	19935	MNG99350	MXM99350
G 340 ti.32, ti.40 (8x4)	01.90-08.91	AV2	414x175	RT	19935	MNG99350	MXM99350
G 340 ti.32, ti.40 (8x4)	01.90-08.91	AR2	414x175	RT	19935	MNG99350	MXM99350
G 340 ti.32, ti.40 (8x4)	01.90-08.91	AR	414x175	RT	19935	MNG99350	MXM99350
G 340ti	01.90-08.91	AV	414x175	RT	19935	MNG99350	MXM99350
G 340ti	01.90-08.91	AR	414x175	RT	19935	MNG99350	MXM99350
G 340ti	01.90-08.91	AV	414x150	RT	19934	MNG99340	MXM99340
G 340ti	01.90-08.91	AR	414x175	RT	19935	MNG99350	MXM99350

G - MAXTER

G 230ti, 235, 270, 280 (6x4)	01.90-08.91	AV	414x175	RT	19935	MNG99350	MXM99350
G 230ti, 235, 270, 280 (6x4)	01.90-08.91	AR2	414x175	RT	19935	MNG99350	MXM99350
G 230ti, 235, 270, 280 (6x4)	01.90-08.91	AR	414x175	RT	19935	MNG99350	MXM99350
G 300, 340ti (6x4)	01.90-08.91	AV	414x175	RT	19935	MNG99350	MXM99350
G 300, 340ti (6x4)	01.90-08.91	AR2	414x175	RT	19935	MNG99350	MXM99350
G 300, 340ti (6x4)	01.90-08.91	AR	414x175	RT	19935	MNG99350	MXM99350

APPLICATION PAR MODELES

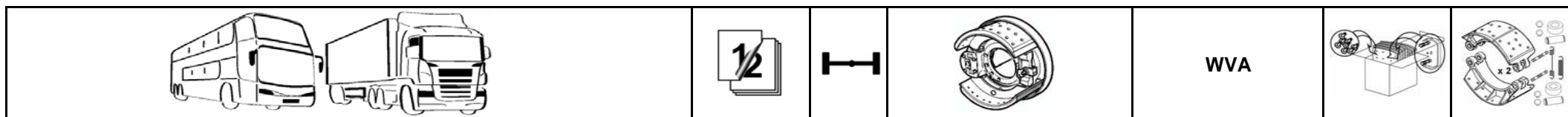

RENAULT TRUCKS ...

KERAX

260.19 (4x2)	1997-09.05	AV	414x175	RT	19935	MNG99350K	MXM99350K
260.19 (4x2)	1997-09.05	AR	414x220	RT	19187	MNG91870K	MXM91870K
300.19, 340.19, 385.19T, 400.19 (4x2)	1997-09.05	AV	414x175	RT	19935	MNG99350K	MXM99350K
300.19, 340.19, 385.19T, 400.19 (4x2)	1997-09.05	AR	414x220	RT	19187	MNG91870K	MXM91870K
300.26, 340.26, 385.26, 34, 34T (6x4)	1997-09.05	AV	414x175	RT	19935	MNG99350K	MXM99350K
300.26, 340.26, 385.26, 34, 34T (6x4)	1997-09.05	AR2	414x175	RT	19935	MNG99350K	MXM99350K
300.26, 340.26, 385.26, 34, 34T (6x4)	1997-09.05	AR	414x220	RT	19187	MNG91870K	MXM91870K
400.26, 34, 34T (6x4)	1997-09.05	AV	414x175	RT	19935	MNG99350K	MXM99350K
400.26, 34, 34T (6x4)	1997-09.05	AR2	414x175	RT	19935	MNG99350K	MXM99350K
400.26, 34, 34T (6x4)	1997-09.05	AR	414x220	RT	19187	MNG91870K	MXM91870K
340.32, 385.32, 40, 400.32 (8x4)	1997-09.05	AV	414x175	RT	19935	MNG99350K	MXM99350K
340.32, 385.32, 40, 400.32 (8x4)	1997-09.05	AV2	414x175	RT	19935	MNG99350K	MXM99350K
340.32, 385.32, 40, 400.32 (8x4)	1997-09.05	AR2	414x220	RT	19187	MNG91870K	MXM91870K
340.32, 385.32, 40, 400.32 (8x4)	1997-09.05	AR	414x220	RT	19187	MNG91870K	MXM91870K
370.18, 370.26, 370.32	10.05-	AV	410x175	MERITOR	19090	MNG90900	MXM90900
370.18, 370.26, 370.32	10.05-	AR	410x225	MERITOR	19068	MNG90680	MXM90680
410.18, 410.26, 410.32	10.05-	AV	410x175	MERITOR	19090	MNG90900	MXM90900
410.18, 410.26, 410.32	10.05-	AR	410x225	MERITOR	19068	MNG90680	MXM90680
450.18, 450.26, 450.32	10.05-	AV	410x175	MERITOR	19090	MNG90900	MXM90900
450.18, 450.26, 450.32	10.05-	AR	410x225	MERITOR	19068	MNG90680	MXM90680
460.32, 500.32	05.06-	AV	410x175	MERITOR	19090	MNG90900	MXM90900
460.32, 500.32	05.06-	AR	410x225	MERITOR	19068	MNG90680	MXM90680

MAGNUM AE

AE 385ti.18, AE 385ti.18T	01.93-10.96	AR	414x220	RT	19187	MNG91870	MXM91870
AE 385ti.19, AE 385ti.19T	01.93-10.96	AR	414x220	RT	19187	MNG91870	MXM91870
AE 385ti.24, AE 385ti.26	01.93-10.96	AR2	414x175	RT	19935	MNG99350	MXM99350
AE 385ti.24, AE 385ti.26	01.93-10.96	AR2	414x220	RT	19187	MNG91870	MXM91870
AE 385ti.24, AE 385ti.26	01.93-10.96	AR	414x220	RT	19187	MNG91870	MXM91870
AE 390.18, AE 390.18T	09.96-10.04	AR	414x220	RT	19187	MNG91870	MXM91870
AE 390.19, AE 390.19T	09.96-10.04	AR	414x220	RT	19187	MNG91870	MXM91870
AE 390.26	09.96-10.04	AR2	414x220	RT	19187	MNG91870	MXM91870
AE 390.26	09.96-10.04	AR	414x220	RT	19187	MNG91870	MXM91870
AE 420ti.18, AE 420ti.18T	01.93-12.96	AR	414x175	RT	19935	MNG99350	MXM99350
AE 420ti.18, AE 420ti.18T	01.93-12.96	AR	414x220	RT	19187	MNG91870	MXM91870
AE 420ti.19, AE 420ti.19T	01.93-12.96	AR	414x175	RT	19935	MNG99350	MXM99350
AE 420ti.19, AE 420ti.19T	01.93-12.96	AR	414x220	RT	19187	MNG91870	MXM91870

APPLICATION PAR MODELES

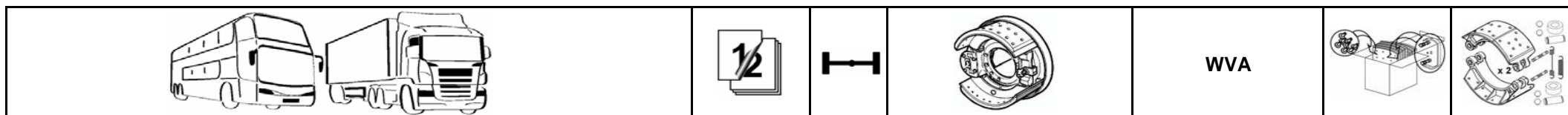

RENAULT TRUCKS ../..

MAGNUM AE ../..

AE 420ti.24, AE 420ti.24T	01.93-12.96	AR	414x175	RT	19935	MNG99350	MXM99350
AE 420ti.24, AE 420ti.24T	01.93-12.96	AR2	414x220	RT	19187	MNG91870	MXM91870
AE 420ti.24, AE 420ti.24T	01.93-12.96	AR	414x220	RT	19187	MNG91870	MXM91870
AE 420ti.26, 420ti.26T	01.93-12.96	AR	414x175	RT	19935	MNG99350	MXM99350
AE 420ti.26, 420ti.26T	01.93-12.96	AR2	414x220	RT	19187	MNG91870	MXM91870
AE 420ti.26, 420ti.26T	01.93-12.96	AR	414x220	RT	19187	MNG91870	MXM91870
AE 430.18, AE 430.18T	09.96-10.04	AR	414x220	RT	19187	MNG91870	MXM91870
AE 430.19, AE 430.19T	09.96-10.04	AR	414x220	RT	19187	MNG91870	MXM91870
AE 430.26, AE 430.26T	09.96-10.04	AR2	414x220	RT	19187	MNG91870	MXM91870
AE 430.26, AE 430.26T	09.96-10.04	AR	414x220	RT	19187	MNG91870	MXM91870
AE 470.18, AE 470.18T	11.96-10.04	AR	414x220	RT	19187	MNG91870	MXM91870
AE 470.19, AE 470.19T	11.96-10.04	AR	414x220	RT	19187	MNG91870	MXM91870
AE 470.26	01.97-10.04	AR2	414x220	RT	19187	MNG91870	MXM91870
AE 470.26	01.97-10.04	AR	414x220	RT	19187	MNG91870	MXM91870
AE 470.26T	01.98-10.04	AR2	414x150	RT	19934	MNG99340	MXM99340
AE 470.26T	01.98-10.04	AR	414x175	RT	19935	MNG99350	MXM99350
AE 520.18, AE 520.18T	01.93-12.96	AR	414x175	RT	19935	MNG99350	MXM99350
AE 520.18, AE 520.18T	01.93-10.04	AR	414x220	RT	19187	MNG91870	MXM91870
AE 520.19, AE 520.19T	01.93-12.96	AR	414x175	RT	19935	MNG99350	MXM99350
AE 520.19, AE 520.19T	01.93-10.04	AR	414x220	RT	19187	MNG91870	MXM91870
AE 520.22, AE 520.22T	01.93-12.96	AR	414x175	RT	19935	MNG99350	MXM99350
AE 520.24, AE 520.24T	01.93-10.04	AR2	414x175	RT	19935	MNG99350	MXM99350
AE 520.24, AE 520.24T	01.93-10.04	AR	414x220	RT	19187	MNG91870	MXM91870
AE 520.26, AE 520.26T	01.93-10.04	AR2	414x175	RT	19935	MNG99350	MXM99350
AE 520.26, AE 520.26T	01.93-10.04	AR	414x220	RT	19187	MNG91870	MXM91870
AE 560.18, AE 560.18T	04.96-10.04	AR	414x220	RT	19187	MNG91870	MXM91870
AE 560.19, AE 560.19T	04.96-10.04	AR	414x220	RT	19187	MNG91870	MXM91870
AE 560.26, AE 560.26T	04.96-10.04	AR2	414x220	RT	19187	MNG91870	MXM91870
AE 560.26, AE 560.26T	04.96-10.04	AR	414x220	RT	19187	MNG91870	MXM91870

PREMIUM

Distribution 210.16, 220.18, 210.18D	04.96-05.06	AR	414x220	RT	19187	MNG91870	MXM91870
Distribution 250.16, 250.18D, 250.19	04.96-05.06	AR	414x220	RT	19187	MNG91870	MXM91870
Distribution 260.16, 260.18, 260.19	04.96-05.06	AR	414x220	RT	19187	MNG91870	MXM91870
Distribution 270.18	08.00-05.06	AR	414x220	RT	19187	MNG91870	MXM91870
Distribution 300.16D, 300.16T	04.96-05.06	AR	414x220	RT	19187	MNG91870	MXM91870
Distribution 300.18D, 300.18D/T	04.96-05.06	AR	414x220	RT	19187	MNG91870	MXM91870

APPLICATION PAR MODELES

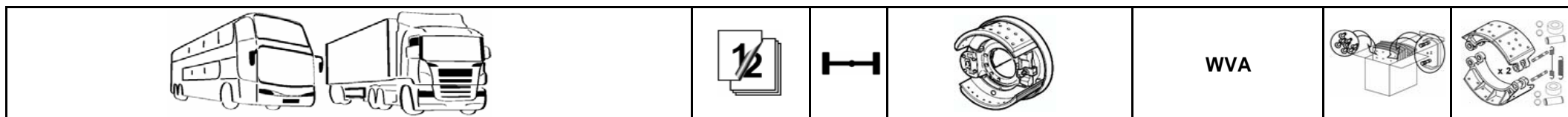

RENAULT TRUCKS ../..

PREMIUM ../..

Distribution 300.19, 300.19D/T	04.96-05.06	AR	414x220	RT	19187	MNG91870	MXM91870
Distribution 300.26D	04.96-05.06	AR	414x220	RT	19187	MNG91870	MXM91870
Distribution 320.18, 320.18 D	08.00-05.06	AR	414x220	RT	19187	MNG91870	MXM91870
Distribution 320.24D, 320.26D	08.00-05.06	AR	414x220	RT	19187	MNG91870	MXM91870
Distribution 340.18D, 340.18D/T	04.96-05.06	AR	414x220	RT	19187	MNG91870	MXM91870
Distribution 340.19D, 340.19D/T	04.96-05.06	AR	414x220	RT	19187	MNG91870	MXM91870
Distribution 340.26D	04.96-05.06	AR	414x220	RT	19187	MNG91870	MXM91870
Distribution 370.18, 370.18D	08.00-05.06	AR	414x220	RT	19187	MNG91870	MXM91870
Distribution 370.24D, 370.26D	08.00-05.06	AR	414x220	RT	19187	MNG91870	MXM91870
Distribution 400.18D, 400.18D/T	01.00-05.06	AR	414x220	RT	19187	MNG91870	MXM91870
Distribution 420.18, 420.18D	08.00-05.06	AR	414x220	RT	19187	MNG91870	MXM91870
Route 300.16	09.96-07.00	AR	414x220	RT	19187	MNG91870	MXM91870
Route 300.18, 300.18T	09.96-07.00	AR	414x220	RT	19187	MNG91870	MXM91870
Route 300.19, 300.19T	09.96-07.00	AR	414x220	RT	19187	MNG91870	MXM91870
Route 340.18, 340.18T	04.96-07.00	AR	414x220	RT	19187	MNG91870	MXM91870
Route 340.19, 340.19T	04.96-07.00	AR	414x220	RT	19187	MNG91870	MXM91870
Route 340.24	04.96-07.00	AR	414x220	RT	19187	MNG91870	MXM91870
Route 340.26	04.96-07.00	AR	414x220	RT	19187	MNG91870	MXM91870
Route 385.18, 385.18T	04.96-07.00	AR	414x220	RT	19187	MNG91870	MXM91870
Route 385.19, 385.19T	04.96-07.00	AR	414x220	RT	19187	MNG91870	MXM91870
Route 385.24, 385.24T	04.96-07.00	AR	414x220	RT	19187	MNG91870	MXM91870
Route 385.26	04.96-07.00	AR	414x220	RT	19187	MNG91870	MXM91870
Route 400.18, 400.18T	04.96-07.00	AR	414x220	RT	19187	MNG91870	MXM91870
Route 400.19, 400.19T	04.96-07.00	AR	414x220	RT	19187	MNG91870	MXM91870
Route 400.24, 400.24T	09.96-07.00	AR	414x220	RT	19187	MNG91870	MXM91870
Route 400.26	04.96-07.00	AR	414x220	RT	19187	MNG91870	MXM91870

R - MAJOR

R 310, 330, 340ti, 365.19, 19T, 370, 390	10.84-1988	AV	414x150	RT	19934	MNG99340	MXM99340
R 310, 330, 340ti, 365.19, 19T, 370, 390	10.84-1988	AR	414x175	RT	19935	MNG99350	MXM99350
R 310, 340, 370 (6x4)	05.91-10.96	AV	414x150	RT	19934	MNG99340	MXM99340
R 310, 340, 370 (6x4)	05.91-10.96	AR2	414x150	RT	19934	MNG99340	MXM99340
R 310, 340, 370 (6x4)	05.91-10.96	AR	414x150	RT	19934	MNG99340	MXM99340
R 310, 340, 390 (6x2)	05.91-10.96	AV	414x150	RT	19934	MNG99340	MXM99340
R 310, 340, 390 (6x2)	05.91-10.96	AR2	414x175	RT	19935	MNG99350	MXM99350
R 310, 340, 390 (6x2)	05.91-10.96	AR	414x175	RT	19935	MNG99350	MXM99350
R 310, 360, 370	-09.84	AV	414x150	BENDIX	19049/19199	MNG90490	MXM90490

APPLICATION PAR MODELES

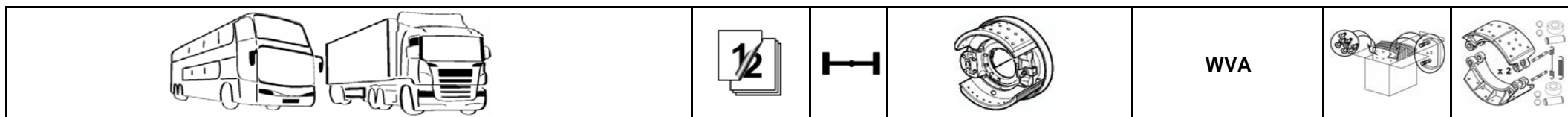

RENAULT TRUCKS ../..

R - MAJOR ../..

R 340 ti (6x2)	1990-10.96	AV	414x175	RT	19935	MNG99350	MXM99350
R 340 ti (6x2)	1990-10.96	AR2	414x175	RT	19935	MNG99350	MXM99350
R 340, 385ti	1990-1992	AV	414x150	RT	19934	MNG99340	MXM99340
R 340, 385ti	1990-1992	AV	414x175	RT	19935	MNG99350	MXM99350
R 340, 385ti	1990-1992	AR	414x175	RT	19935	MNG99350	MXM99350
R 350 (4x2)	05.91-10.96	AR	414x150	RT	19934	MNG99340	MXM99340
R 350 (4x2)	05.91-10.96	AR	414x175	RT	19935	MNG99350	MXM99350
R 360.35,..35 T (6x2/4)	-1983	AV	414x150	BENDIX	19049/19199	MNG90490	MXM90490
R 380, 385ti, 420ti.19T	05.91-10.96	AR	414x175	RT	19935	MNG99350	MXM99350
R 385 ti (6x2)	1990-10.96	AV	414x175	RT	19935	MNG99350	MXM99350
R 385 ti (6x2)	1990-10.96	AR2	414x175	RT	19935	MNG99350	MXM99350
R 385ti, 420 TS (6x4)	05.91-10.96	AV	414x150	RT	19934	MNG99340	MXM99340
R 385ti, 420 TS (6x4)	1990-10.96	AR2	414x175	RT	19935	MNG99350	MXM99350
R 385ti, 420 TS (6x4)	1990-10.96	AR	414x175	RT	19935	MNG99350	MXM99350
R 390 (6x4)	05.91-10.96	AV	414x150	RT	19934	MNG99340	MXM99340
R 390 (6x4)	05.91-10.96	AR2	414x150	RT	19934	MNG99340	MXM99340
R 390 (6x4)	05.91-10.96	AR2	414x175	RT	19935	MNG99350	MXM99350
R 390 (6x4)	05.91-10.96	AR	414x150	RT	19934	MNG99340	MXM99340
R 390 (6x4)	05.91-10.96	AR	414x175	RT	19935	MNG99350	MXM99350
R 420 ti.19T	05.91-10.96	AV	414x150	RT	19934	MNG99340	MXM99340
R 420 ti.19T	1991-	AR	414x175	RT	19935	MNG99350	MXM99350

SCANIA

C-K BUS

CR 112, K 113	1988-	AV	412x178	SCANIA	19931	MNG99310	MXM99310
CR 112, K 113	1988-	AR	412x254	SCANIA	19933	MNG99330	MXM99330
K 92 CR, TR	1984-	AV	412x178	SCANIA	19931	MNG99310	MXM99310
K 92 CR, TR	1984-	AR	412x254	SCANIA	19933	MNG99330	MXM99330

N - BUS

N 112, 113	1983-	AV	412x178	SCANIA	19931	MNG99310	MXM99310
N 112, 113	1983-	AR	412x254	SCANIA	19933	MNG99330	MXM99330

SERIE 3 - 93

93 H (6x4)	1988-	AV	412x127	SCANIA	17991	MNG79910	MXM79910
93 H (6x4)	1988-12.96	AV	412x178	SCANIA	19931	MNG99310	MXM99310
93 H (6x2)	1988-12.96	AV	412x178	SCANIA	19931	MNG99310	MXM99310
93 H (6x2)	1988-12.96	AR2	412x203	SCANIA	19932	MNG99320	MXM99320
93 H (6x4)	1988-12.96	AR2	412x203	SCANIA	19932	MNG99320	MXM99320

APPLICATION PAR MODELES

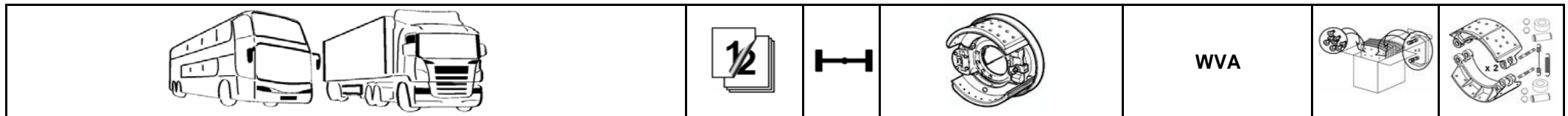

SCANIA ../..								
SERIE 3 - 93 ../..								
93 H (6x2)	1988-12.96	AR	412x127	SCANIA	17991	MNG79910	MXM79910	
93 H (6x2)	1988-12.96	AR	412x178	SCANIA	19931	MNG99310	MXM99310	
93 H (6x4)	1988-12.96	AR	412x203	SCANIA	19932	MNG99320	MXM99320	
93 H, 93 M, 93 HK (4x4)	1988-12.96	AV	412x178	SCANIA	19931	MNG99310	MXM99310	
93 H, 93 M, 93 HK (4x4)	1988-12.96	AR	412x203	SCANIA	19932	MNG99320	MXM99320	
93 ML (6x2/4)	1988-12.96	AV	412x178	SCANIA	19931	MNG99310	MXM99310	
93 ML (6x2/4)	1988-12.96	AR2	412x127	SCANIA	17991	MNG79910	MXM79910	
93 ML (6x2/4)	1988-12.96	AR	412x203	SCANIA	19932	MNG99320	MXM99320	
SERIE 3 - 113								
113	1988-12.96	AV	412x127	SCANIA	17991	MNG79910	MXM79910	
113	1988-12.96	AV	412x178	SCANIA	19931	MNG99310	MXM99310	
113 (6x4)	1988-12.96	AV	412x178	SCANIA	19931	MNG99310	MXM99310	
113 (6x4)	1988-12.96	AR2	412x203	SCANIA	19932	MNG99320	MXM99320	
113	1988-12.96	AR	412x203	SCANIA	19932	MNG99320	MXM99320	
113 (6x4)	1988-12.96	AR	412x203	SCANIA	19932	MNG99320	MXM99320	
113	1988-12.96	AR	412x254	SCANIA	19933	MNG99330	MXM99330	
113 (6x4)	1988-12.96	AR	412x254	SCANIA	19933	MNG99330	MXM99330	
113 H (6x2)	1988-12.96	AV	412x178	SCANIA	19931	MNG99310	MXM99310	
113 H (6x2)	1988-12.96	AR2	412x178	SCANIA	19931	MNG99310	MXM99310	
113 H (6x2)	1988-12.96	AR	412x203	SCANIA	19932	MNG99320	MXM99320	
113 HK (4x4)	1988-12.96	AV	412x178	SCANIA	19931	MNG99310	MXM99310	
113 HK (4x4)	1988-12.96	AR	412x203	SCANIA	19932	MNG99320	MXM99320	
113 HK, MK (8x4)	1988-12.96	AV	412x178	SCANIA	19931	MNG99310	MXM99310	
113 HK, MK (8x4)	1988-12.96	AV2	412x178	SCANIA	19931	MNG99310	MXM99310	
113 HK, MK (8x4)	1988-12.96	AR2	412x203	SCANIA	19932	MNG99320	MXM99320	
113 HK, MK (8x4)	1988-12.96	AR	412x203	SCANIA	19932	MNG99320	MXM99320	
113 HL (8x2)	1988-12.96	AV	412x178	SCANIA	19931	MNG99310	MXM99310	
113 HL (8x2)	1988-12.96	AV2	412x178	SCANIA	19931	MNG99310	MXM99310	
113 HL (8x2)	1988-12.96	AR2	412x203	SCANIA	19932	MNG99320	MXM99320	
113 HL (8x2)	1988-12.96	AR	412x178	SCANIA	19931	MNG99310	MXM99310	
113 HL, M (6x2)	1988-12.96	AV	412x178	SCANIA	19931	MNG99310	MXM99310	
113 HL, M (6x2)	1988-12.96	AR2	412x203	SCANIA	19932	MNG99320	MXM99320	
113 HL, M (6x2)	1988-12.96	AR	412x127	SCANIA	17991	MNG79910	MXM79910	
113 HL, M (6x2)	1988-12.96	AR	412x178	SCANIA	19931	MNG99310	MXM99310	
113 MA (6x2/4)	1988-12.96	AV	412x178	SCANIA	19931	MNG99310	MXM99310	
113 MA (6x2/4)	1988-12.96	AR2	412x127	SCANIA	17991	MNG79910	MXM79910	

APPLICATION PAR MODELES

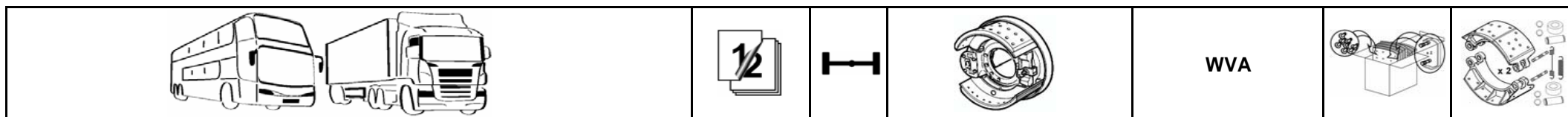

SCANIA/									
SERIE 3 - 113 ../									
113 MA (6x2/4)	1988-12.96	AR	412x254	SCANIA	19933	MNG99330	MXM99330		
143 E (6x4)	1988-12.96	AV	412x178	SCANIA	19931	MNG99310	MXM99310		
143 E (6x4)	1988-12.96	AR2	412x203	SCANIA	19932	MNG99320	MXM99320		
143 E (6x4)	1988-12.96	AR2	412x254	SCANIA	19933	MNG99330	MXM99330		
143 E (6x4)	1988-12.96	AR	412x203	SCANIA	19932	MNG99320	MXM99320		
143 E (6x4)	1988-12.96	AR	412x254	SCANIA	19933	MNG99330	MXM99330		
143 H, M	1988-12.96	AV	412x178	SCANIA	19931	MNG99310	MXM99310		
143 H, M (6x2)	1988-12.96	AV	412x178	SCANIA	19931	MNG99310	MXM99310		
143 H, M (6x2)	1988-12.96	AR2	412x203	SCANIA	19932	MNG99320	MXM99320		
143 H, M (6x2)	1988-12.96	AR	412x178	SCANIA	19931	MNG99310	MXM99310		
SERIE 3 - 143									
143 H, M	1988-12.96	AR	412x203	SCANIA	19932	MNG99320	MXM99320		
143 H, M	1988-12.96	AR	412x254	SCANIA	19933	MNG99330	MXM99330		
143 M (6x2/4)	1988-12.96	AV	412x178	SCANIA	19931	MNG99310	MXM99310		
143 M (6x2/4)	1988-12.96	AR2	412x127	SCANIA	17991	MNG79910	MXM79910		
143 M (6x2/4)	1988-12.96	AR	412x254	SCANIA	19933	MNG99330	MXM99330		
SERIE 4 - 94									
94 C/D/G/L	01.97-	AV	412x178	SCANIA	19931	MNG99310	MXM99310		
94 C/D/G/L (6x2/4)	01.97-	AV	412x178	SCANIA	19931	MNG99310	MXM99310		
94 C/D/G/L (6x2/4)	01.97-	AR2	412x254	SCANIA	19933	MNG99330	MXM99330		
94 C/D/G/L (6x2/4)	01.97-	AR	412x127	SCANIA	17991	MNG79910	MXM79910		
94 C/D/G/L	01.97-	AR	412x203	SCANIA	19932	MNG99320	MXM99320		
94 C/D/G/L	01.97-	AR	412x254	SCANIA	19933	MNG99330	MXM99330		
94 C/G	01.97-	AV	412x178	SCANIA	19931	MNG99310	MXM99310		
94 C/G	01.97-	AV	412x203	SCANIA	19932	MNG99320	MXM99320		
94 C/G	01.97-	AV2	412x178	SCANIA	19931	MNG99310	MXM99310		
94 C/G	01.97-	AV2	412x203	SCANIA	19932	MNG99320	MXM99320		
94 C/G	01.97-	AR2	412x178	SCANIA	19931	MNG99310	MXM99310		
94 C/G	01.97-	AR2	412x203	SCANIA	19932	MNG99320	MXM99320		
94 C/G	01.97-	AR	412x178	SCANIA	19931	MNG99310	MXM99310		
94 C/G	01.97-	AR	412x203	SCANIA	19932	MNG99320	MXM99320		
94 G/L (6x2)	01.97-	AV	412x178	SCANIA	19931	MNG99310	MXM99310		
94 G/L (6x2)	01.97-	AR2	412x203	SCANIA	19932	MNG99320	MXM99320		
94 G/L (6x2)	01.97-	AR2	412x254	SCANIA	19933	MNG99330	MXM99330		
94 G/L (6x2)	01.97-	AR	412x178	SCANIA	19931	MNG99310	MXM99310		

APPLICATION PAR MODELES

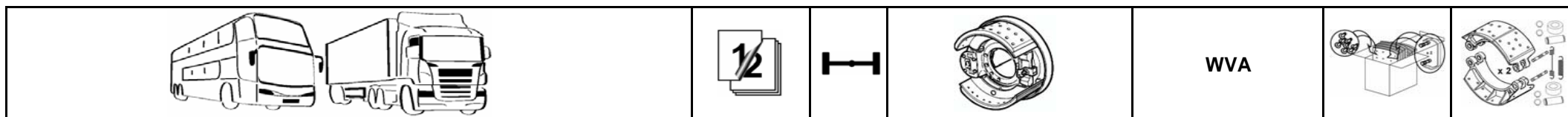

SCANIA ../..								
SERIE 4 - 114								
114 C/D/G/L (6x2/4)	01.97-	AV	412x178	SCANIA	19931	MNG99310	MXM99310	
114 C/D/G/L	01.97-	AV	412x178	SCANIA	19931	MNG99310	MXM99310	
114 C/D/G/L (6x2/4)	01.97-	AR2	412x254	SCANIA	19933	MNG99330	MXM99330	
114 C/D/G/L (6x2/4)	01.97-	AR	412x127	SCANIA	17991	MNG79910	MXM79910	
114 C/D/G/L	01.97-	AR	412x203	SCANIA	19932	MNG99320	MXM99320	
114 C/D/G/L	01.97-	AR	412x254	SCANIA	19933	MNG99330	MXM99330	
114 C/G	01.97-	AV	412x178	SCANIA	19931	MNG99310	MXM99310	
114 C/G	01.97-	AV	412x203	SCANIA	19932	MNG99320	MXM99320	
114 C/G	01.97-	AV2	412x178	SCANIA	19931	MNG99310	MXM99310	
114 C/G	01.97-	AV2	412x203	SCANIA	19932	MNG99320	MXM99320	
114 C/G	01.97-	AR2	412x178	SCANIA	19931	MNG99310	MXM99310	
114 C/G	01.97-	AR2	412x203	SCANIA	19932	MNG99320	MXM99320	
114 C/G	01.97-	AR	412x178	SCANIA	19931	MNG99310	MXM99310	
114 C/G	01.97-	AR	412x203	SCANIA	19932	MNG99320	MXM99320	
114 G/L (6x2)	01.97-	AV	412x178	SCANIA	19931	MNG99310	MXM99310	
114 G/L (6x2)	01.97-	AR2	412x203	SCANIA	19932	MNG99320	MXM99320	
114 G/L (6x2)	01.97-	AR2	412x254	SCANIA	19933	MNG99330	MXM99330	
114 G/L (6x2)	01.97-	AR	412x178	SCANIA	19931	MNG99310	MXM99310	
SERIE 4 - 124								
124 C/G (6x4)	01.97-	AV	412x178	SCANIA	19931	MNG99310	MXM99310	
124 C/G (8x4)	01.97-	AV	412x178	SCANIA	19931	MNG99310	MXM99310	
124 C/G (8x4)	01.97-	AV	412x203	SCANIA	19932	MNG99320	MXM99320	
124 C/G (6x4)	01.97-	AV	412x203	SCANIA	19932	MNG99320	MXM99320	
124 C/G (8x4)	01.97-	AV2	412x178	SCANIA	19931	MNG99310	MXM99310	
124 C/G (8x4)	01.97-	AV2	412x203	SCANIA	19932	MNG99320	MXM99320	
124 C/G (8x4)	01.97-	AR2	412x178	SCANIA	19931	MNG99310	MXM99310	
124 C/G (6x4)	01.97-	AR2	412x203	SCANIA	19932	MNG99320	MXM99320	
124 C/G (8x4)	01.97-	AR2	412x203	SCANIA	19932	MNG99320	MXM99320	
124 C/G (6x4)	01.97-	AR2	412x254	SCANIA	19933	MNG99330	MXM99330	
124 C/G (8x4)	01.97-	AR	412x178	SCANIA	19931	MNG99310	MXM99310	
124 C/G (8x4)	01.97-	AR	412x203	SCANIA	19932	MNG99320	MXM99320	
124 C/G (6x4)	01.97-	AR	412x203	SCANIA	19932	MNG99320	MXM99320	
124 C/G (6x4)	01.97-	AR	412x254	SCANIA	19933	MNG99330	MXM99330	
124 C/G/L (4x2)	01.97-	AV	412x178	SCANIA	19931	MNG99310	MXM99310	
124 C/G/L (4x2)	01.97-	AV	412x203	SCANIA	19932	MNG99320	MXM99320	
124 C/G/L (4x2)	01.97-	AR	412x203	SCANIA	19932	MNG99320	MXM99320	

APPLICATION PAR MODELES

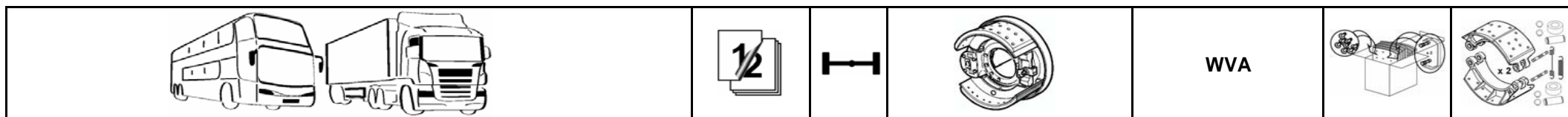

SCANIA/

SERIE 4 - 124/

124 C/G/L (4x2)	01.97-	AR	412x254	SCANIA	19933	MNG99330	MXM99330
124 G/L (6x2x4)	01.97-	AV	412x178	SCANIA	19931	MNG99310	MXM99310
124 G/L (6x2)	01.97-	AV	412x178	SCANIA	19931	MNG99310	MXM99310
124 G/L (6x2)	01.97-	AR2	412x203	SCANIA	19932	MNG99320	MXM99320
124 G/L (6x2x4)	01.97-	AR2	412x254	SCANIA	19933	MNG99330	MXM99330
124 G/L (6x2)	01.97-	AR2	412x254	SCANIA	19933	MNG99330	MXM99330
124 G/L (6x2x4)	01.97-	AR	412x127	SCANIA	17991	MNG79910	MXM79910
124 G/L (6x2)	01.97-	AR	412x178	SCANIA	19931	MNG99310	MXM99310
144 C, G (6x4)	01.97-	AV	412x178	SCANIA	19931	MNG99310	MXM99310
144 C, G (6x4)	01.97-	AV	412x203	SCANIA	19932	MNG99320	MXM99320
144 C, G (6x4)	01.97-	AR2	412x203	SCANIA	19932	MNG99320	MXM99320
144 C, G (6x4)	01.97-	AR2	412x254	SCANIA	19933	MNG99330	MXM99330
144 C, G (6x4)	01.97-	AR	412x203	SCANIA	19932	MNG99320	MXM99320

SERIE 4 - 144

144 C, G (6x4)	01.97-	AR	412x254	SCANIA	19933	MNG99330	MXM99330
144 C, G, L (4x2)	01.97-	AV	412x178	SCANIA	19931	MNG99310	MXM99310
144 C, G, L (4x2)	01.97-	AV	412x203	SCANIA	19932	MNG99320	MXM99320
144 C, G, L (4x2)	01.97-	AR	412x203	SCANIA	19932	MNG99320	MXM99320
144 C, G, L (4x2)	01.97-	AR	412x254	SCANIA	19933	MNG99330	MXM99330
144 C/G (8x4)	01.97-	AV	412x178	SCANIA	19931	MNG99310	MXM99310
144 C/G (8x4)	01.97-	AV	412x203	SCANIA	19932	MNG99320	MXM99320
144 C/G (8x4)	01.97-	AV2	412x178	SCANIA	19931	MNG99310	MXM99310
144 C/G (8x4)	01.97-	AV2	412x203	SCANIA	19932	MNG99320	MXM99320
144 C/G (8x4)	01.97-	AR2	412x178	SCANIA	19931	MNG99310	MXM99310
144 C/G (8x4)	01.97-	AR2	412x203	SCANIA	19932	MNG99320	MXM99320
144 C/G (8x4)	01.97-	AR	412x178	SCANIA	19931	MNG99310	MXM99310
144 C/G (8x4)	01.97-	AR	412x203	SCANIA	19932	MNG99320	MXM99320
144 G/L (6x2)	01.97-	AV	412x178	SCANIA	19931	MNG99310	MXM99310
144 G/L (6x2)	01.97-	AR2	412x203	SCANIA	19932	MNG99320	MXM99320
144 G/L (6x2)	01.97-	AR2	412x254	SCANIA	19933	MNG99330	MXM99330
144 G/L (6x2)	01.97-	AR	412x178	SCANIA	19931	MNG99310	MXM99310

APPLICATION PAR MODELES

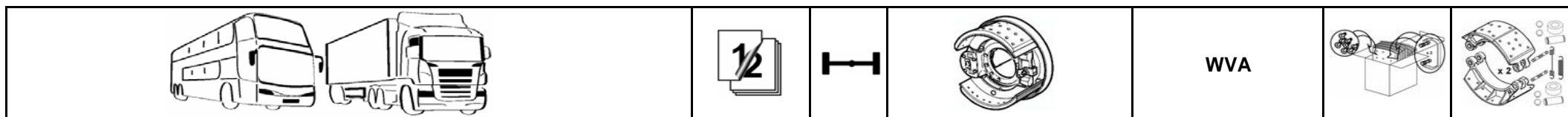

VOLVO TRUCKS

B-SERIE

B10 B	1992-	AV	410x200	MERITOR	19071	MNG90710	MXM90710
B10 B	1992-	AR	410x225	MERITOR	19068	MNG90680	MXM90680
B10 L, B12 L	1995-	AR2	410x225	MERITOR	19068	MNG90680	MXM90680
B10 L, B12 L	1995-	AR	410x225	MERITOR	19068	MNG90680	MXM90680
B12	1986-	AV	410x200	MERITOR	19071	MNG90710	MXM90710
B12	1986-	AR2	410x225	MERITOR	19068	MNG90680	MXM90680
B7	1987-	AV	410x150	MERITOR	19941	MNG99410	MXM99410
B7	1987-	AR	410x175	MERITOR	19090	MNG90900	MXM90900
Olympian	1988-	AV	410x175	MERITOR	19090	MNG90900	MXM90900
Olympian	1988-	AR2	410x225	MERITOR	19068	MNG90680	MXM90680
Olympian	1988-	AR	410x175	MERITOR	19090	MNG90900	MXM90900

F - SERIE

F 7, F 10, F 12, F 16 (8x4)	1985-12.94	AV	410x150	MERITOR	19941	MNG99410	MXM99410
F 7, F 10, F 12, F 16 (8x4)	1985-12.94	AV	410x175	MERITOR	19090	MNG90900	MXM90900
F 7, F 10, F 12, F 16 (8x4)	1985-12.94	AV	410x200	MERITOR	19071	MNG90710	MXM90710
F 7, F 10, F 12, F 16 (8x4)	1985-12.94	AV	410x225	MERITOR	19068	MNG90680	MXM90680
F 7, F 10, F 12, F 16 (8x4)	1985-12.94	AR2	410x125	MERITOR	17992	MNG79920	MXM79920
F 7, F 10, F 12, F 16 (8x4)	1985-12.94	AR	410x150	MERITOR	19941	MNG99410	MXM99410
F 7, F 10, F 12, F 16 (8x4)	1985-12.94	AR	410x175	MERITOR	19090	MNG90900	MXM90900
F 7, F 10, F 12, F 16 (8x4)	1985-12.94	AR	410x200	MERITOR	19071	MNG90710	MXM90710
F 7, F 10, F 12, F 16 (8x4)	1985-12.94	AR	410x225	MERITOR	19068	MNG90680	MXM90680

FL 12/16

FL12, 20	1984-08.98	AV	410x175	MERITOR	19090	MNG90900	MXM90900
FL12, 20	1984-08.98	AR	410x225	MERITOR	19068	MNG90680	MXM90680
FL12, 25	1985-08.98	AV	410x175	MERITOR	19090	MNG90900	MXM90900
FL12, 25	1985-08.98	AR2	410x225	MERITOR	19068	MNG90680	MXM90680

FH 12/16

FH 12 P 340, FH16 P 470	10.93-	AV	410x200	MERITOR	19071	MNG90710	MXM90710
FH 12 P 340, FH16 P 470	10.93-	AR	410x225	MERITOR	19068	MNG90680	MXM90680
FH 12 T 340/380	10.93-	AV	410x175	MERITOR	19090	MNG90900	MXM90900
FH 12 T 340/380	10.93-	AV	410x200	MERITOR	19071	MNG90710	MXM90710
FH 12 T 340/380	10.93-	AR2	410x125	MERITOR	17992	MNG79920	MXM79920
FH 12 T 340/380	10.93-	AR	410x225	MERITOR	19068	MNG90680	MXM90680
FH 12 P 380, P 420, FH 16 P 470 (6x2)	10.93-	AV	410x200	MERITOR	19071	MNG90710	MXM90710
FH 12 P 380, P 420, FH 16 P 470 (6x2)	10.93-	AR2	410x225	MERITOR	19068	MNG90680	MXM90680
FH 12 420, FH 16 T470, T520 (6x4)	10.93-	AV	410x200	MERITOR	19071	MNG90710	MXM90710

APPLICATION PAR MODELES

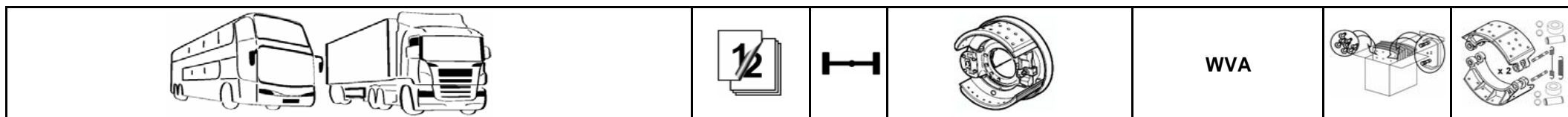

VOLVO TRUCKS ../..

FH 12/16 ../..

FH 12 420, FH 16 T470, T520 (6x4)	10.93-	AR2	410x200	MERITOR	19071	MNG90710	MXM90710
FH 12 420, FH 16 T470, T520 (6x4)	10.93-	AR	410x200	MERITOR	19071	MNG90710	MXM90710
FH 16 T 470, T 520	10.93-	AV	410x175	MERITOR	19090	MNG90900	MXM90900
FH 16 T 470, T 520	10.93-	AV	410x200	MERITOR	19071	MNG90710	MXM90710
FH 16 T 470, T 520	10.93-12.09	AR2	410x125	MERITOR	17992	MNG79920	MXM79920
FH 16 T 470, T 520	10.93-	AR	410x225	MERITOR	19068	MNG90680	MXM90680

FM 7

FM7 42R (B7 DK1) (4x2)	1998-12.01	AV	410x175	MERITOR	19090	MNG90900	MXM90900
FM7 42R (B7 DK1) (4x2)	1998-12.01	AR2	410x225	MERITOR	19068	MNG90680	MXM90680
FM7 42R (B7 DK1) (4x2)	1998-12.01	AR	410x200	MERITOR	19071	MNG90710	MXM90710
FM7 42R (B7 GK3/GK1) (4x2)	1998-12.01	AV	410x175	MERITOR	19090	MNG90900	MXM90900
FM7 42R (B7 GK3/GK1) (4x2)	1998-12.01	AR	410x200	MERITOR	19071	MNG90710	MXM90710
FM7 62R (B7 DK1) (6x2)	1998-12.01	AV	410x175	MERITOR	19090	MNG90900	MXM90900
FM7 62R (B7 DK1) (6x2)	1998-12.01	AR2	410x225	MERITOR	19068	MNG90680	MXM90680
FM7 62R (B7 DK1) (6x2)	1998-12.01	AR	410x200	MERITOR	19071	MNG90710	MXM90710
FM7 62R (B7 GK1) (6x2)	1998-12.01	AV	410x175	MERITOR	19090	MNG90900	MXM90900
FM7 62R (B7 GK1) (6x2)	1998-12.01	AR2	410x225	MERITOR	19068	MNG90680	MXM90680
FM7 62R (B7 GK1) (6x2)	1998-12.01	AR	410x200	MERITOR	19071	MNG90710	MXM90710
FM7 62R (B7 GK3) (6x2)	1998-12.01	AV	410x175	MERITOR	19090	MNG90900	MXM90900
FM7 62R (B7 GK3) (6x2)	1998-12.01	AR2	410x200	MERITOR	19071	MNG90710	MXM90710
FM7 62R (B7 GK3) (6x2)	1998-12.01	AR	410x200	MERITOR	19071	MNG90710	MXM90710
FM7 62R (B7 PK1) (6x2)	1998-12.01	AV	410x175	MERITOR	19090	MNG90900	MXM90900
FM7 62R (B7 PK1) (6x2)	1998-12.01	AR2	410x225	MERITOR	19068	MNG90680	MXM90680
FM7 62R (B7 PK1) (6x2)	1998-12.01	AR	410x200	MERITOR	19071	MNG90710	MXM90710
FM7 62R (B7 PK3) (6x2)	1998-12.01	AV	410x175	MERITOR	19090	MNG90900	MXM90900
FM7 62R (B7 PK3) (6x2)	1998-12.01	AR2	410x200	MERITOR	19071	MNG90710	MXM90710
FM7 62R (B7 PK3) (6x2)	1998-12.01	AR	410x200	MERITOR	19071	MNG90710	MXM90710
FM7 62R (B7 TK1) (6x2)	1998-12.01	AV	410x175	MERITOR	19090	MNG90900	MXM90900
FM7 62R (B7 TK1) (6x2)	1998-12.01	AR2	410x225	MERITOR	19068	MNG90680	MXM90680
FM7 62R (B7 TK1) (6x2)	1998-12.01	AR	410x200	MERITOR	19071	MNG90710	MXM90710
FM7 62R (B7 TK3) (6x2)	1998-12.01	AV	410x175	MERITOR	19090	MNG90900	MXM90900
FM7 62R (B7 TK3) (6x2)	1998-12.01	AR2	410x200	MERITOR	19071	MNG90710	MXM90710
FM7 62R (B7 TK3) (6x2)	1998-12.01	AR	410x200	MERITOR	19071	MNG90710	MXM90710
FM7 64R (B7 DM1/MR1) (6x4)	1998-12.01	AV	410x175	MERITOR	19090	MNG90900	MXM90900
FM7 64R (B7 DM1/MR1) (6x4)	1998-12.01	AR2	410x200	MERITOR	19071	MNG90710	MXM90710
FM7 64R (B7 DM1/MR1) (6x4)	1998-12.01	AR	410x200	MERITOR	19071	MNG90710	MXM90710

APPLICATION PAR MODELES

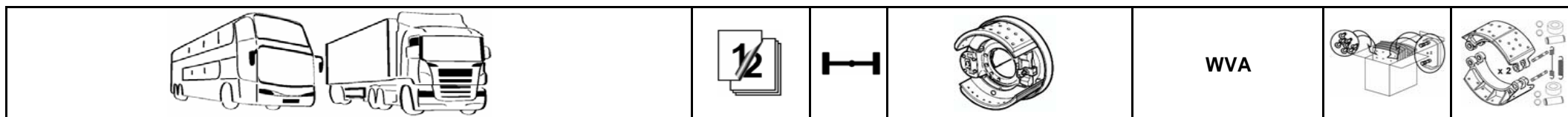

VOLVO TRUCKS ..!..

FM 7 ..!..

FM7 64R (B7 GM1) (6x4)	1998-12.01	AV	410x175	MERITOR	19090	MNG9090	MXM9090
FM7 64R (B7 GM1) (6x4)	1998-12.01	AR2	410x200	MERITOR	19071	MNG90710	MXM90710
FM7 64R (B7 GM1) (6x4)	1998-12.01	AR	410x200	MERITOR	19071	MNG90710	MXM90710
FM7-10 42R (B7 PK3/PK1) (4x2)	1998-12.01	AV	410x175	MERITOR	19090	MNG90900	MXM90900
FM7-10 42R (B7 PK3/PK1) (4x2)	1998-12.01	AR	410x200	MERITOR	19071	MNG90710	MXM90710
FM7-10 42R (B7 TK3) (4x2)	1998-12.01	AV	410x175	MERITOR	19090	MNG90900	MXM90900
FM7-10 42R (B7 TK3) (4x2)	1998-12.01	AR	410x200	MERITOR	19071	MNG90710	MXM90710
FM7-10 42T (B7 PK3/PE3) (4x2)	1998-12.01	AV	410x175	MERITOR	19090	MNG90900	MXM90900
FM7-10 42T (B7 PK3/PE3) (4x2)	1998-12.01	AR	410x200	MERITOR	19071	MNG90710	MXM90710

FM 12/16

FM12 42R (B2 DK1) (4x2)	1998-09.05	AV	410x175	MERITOR	19090	MNG90900	MXM90900
FM12 42R (B2 DK1) (4x2)	1998-09.05	AR	410x200	MERITOR	19071	MNG90710	MXM90710
FM12 42R (B2 DK1) (4x2)	1998-09.05	AR	410x225	MERITOR	19068	MNG90680	MXM90680
FM12 42R (B2 PK1/PK3) (4x2)	1998-09.05	AV	410x175	MERITOR	19090	MNG90900	MXM90900
FM12 42R (B2 PK1/PK3) (4x2)	1998-09.05	AR	410x200	MERITOR	19071	MNG90710	MXM90710
FM12 42R (B2 PK1/PK3) (4x2)	1998-09.05	AR	410x225	MERITOR	19068	MNG90680	MXM90680
FM12 42R (B2 TK3) (4x2)	1998-09.05	AV	410x175	MERITOR	19090	MNG90900	MXM90900
FM12 42R (B2 TK3) (4x2)	1998-09.05	AR	410x200	MERITOR	19071	MNG90710	MXM90710
FM12 42R (B2 TK3) (4x2)	1998-09.05	AR	410x225	MERITOR	19068	MNG90680	MXM90680
FM12 42T (B2 DK1/MK1) (4x2)	1998-09.05	AV	410x175	MERITOR	19090	MNG90900	MXM90900
FM12 42T (B2 DK1/MK1) (4x2)	1998-09.05	AR	410x200	MERITOR	19071	MNG90710	MXM90710
FM12 42T (B2 DK1/MK1) (4x2)	1998-09.05	AR	410x225	MERITOR	19068	MNG90680	MXM90680
FM12 42T road (B2 PK3/PK1/PE3/TK1) (4x2)	1998-09.05	AV	410x175	MERITOR	19090	MNG90900	MXM90900
FM12 42T road (B2 PK3/PK1/PE3/TK1) (4x2)	1998-09.05	AR	410x200	MERITOR	19071	MNG90710	MXM90710
FM12 42T road (B2 PK3/PK1/PE3/TK1) (4x2)	1998-09.05	AR	410x225	MERITOR	19068	MNG90680	MXM90680
FM12 62R (B2 DK1) (6x2)	1998-09.05	AV	410x175	MERITOR	19090	MNG90900	MXM90900
FM12 62R (B2 DK1) (6x2)	1998-09.05	AR2	410x200	MERITOR	19071	MNG90710	MXM90710
FM12 62R (B2 DK1) (6x2)	1998-09.05	AR2	410x225	MERITOR	19068	MNG90680	MXM90680
FM12 62R (B2 DK1) (6x2)	1998-09.05	AR	410x200	MERITOR	19071	MNG90710	MXM90710
FM12 62R (B2 DK1) (6x2)	1998-09.05	AR	410x225	MERITOR	19068	MNG90680	MXM90680
FM12 62R (B2 MK1) (6x2)	1998-09.05	AV	410x175	MERITOR	19090	MNG90900	MXM90900
FM12 62R (B2 MK1) (6x2)	1998-09.05	AR2	410x225	MERITOR	19068	MNG90680	MXM90680
FM12 62R (B2 MK1) (6x2)	1998-09.05	AR	410x225	MERITOR	19068	MNG90680	MXM90680
FM12 62R (B2 PK1/PK3) (6x2)	1998-09.05	AV	410x175	MERITOR	19090	MNG90900	MXM90900
FM12 62R (B2 PK1/PK3) (6x2)	1998-09.05	AR2	410x225	MERITOR	19068	MNG90680	MXM90680
FM12 62R (B2 PK1/PK3) (6x2)	1998-09.05	AR	410x200	MERITOR	19071	MNG90710	MXM90710

APPLICATION PAR MODELES

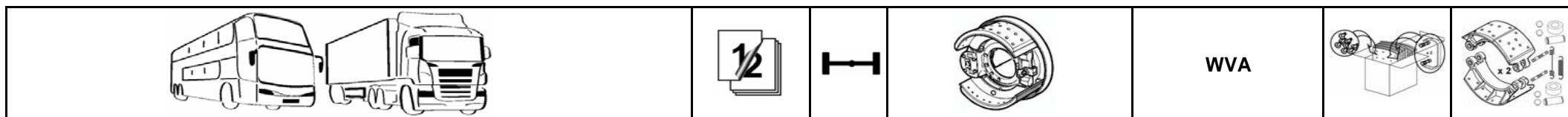

VOLVO TRUCKS ../..

FM 12/16 ../..

FM12 62R (B2 TK1) (6x2)	1998-09.05	AV	410x175	MERITOR	19090	MNG9090	MXM9090
FM12 62R (B2 TK1) (6x2)	1998-09.05	AR2	410x200	MERITOR	19071	MNG90710	MXM90710
FM12 62R (B2 TK1) (6x2)	1998-09.05	AR	410x200	MERITOR	19071	MNG90710	MXM90710
FM12 62R (B2 TK3) (6x2)	1998-09.05	AV	410x175	MERITOR	19090	MNG90900	MXM90900
FM12 62R (B2 TK3) (6x2)	1998-09.05	AR2	410x225	MERITOR	19068	MNG90680	MXM90680
FM12 62R (B2 TK3) (6x2)	1998-09.05	AR	410x200	MERITOR	19071	MNG90710	MXM90710
FM12 62T road (B2 PK3/TK3) (6x2)	1998-09.05	AV	410x175	MERITOR	19090	MNG90900	MXM90900
FM12 62T road (B2 PK3/TK3) (6x2)	1998-09.05	AR2	410x225	MERITOR	19068	MNG90680	MXM90680
FM12 62T road (B2 PK3/TK3) (6x2)	1998-09.05	AR	410x200	MERITOR	19071	MNG90710	MXM90710
FM12 64R (B2 DR1/DT1/FR1/MR1/MT1) (6x4)	1998-09.05	AV	410x175	MERITOR	19090	MNG90900	MXM90900
FM12 64R (B2 DR1/DT1/FR1/MR1/MT1) (6x4)	1998-09.05	AR2	410x200	MERITOR	19071	MNG90710	MXM90710
FM12 64R (B2 DR1/DT1/FR1/MR1/MT1) (6x4)	1998-09.05	AR	410x200	MERITOR	19071	MNG90710	MXM90710
FM12 64R (B2 PM1) (6x4)	1998-09.05	AV	410x175	MERITOR	19090	MNG90900	MXM90900
FM12 64R (B2 PM1) (6x4)	1998-09.05	AR2	410x200	MERITOR	19071	MNG90710	MXM90710
FM12 64R (B2 PM1) (6x4)	1998-09.05	AR	410x200	MERITOR	19071	MNG90710	MXM90710
FM12 64R (B2 PM3) (6x4)	1998-09.05	AV	410x175	MERITOR	19090	MNG90900	MXM90900
FM12 64R (B2 PM3) (6x4)	1998-09.05	AR2	410x225	MERITOR	19068	MNG90680	MXM90680
FM12 64R (B2 PM3) (6x4)	1998-09.05	AR	410x200	MERITOR	19071	MNG90710	MXM90710
FM12 64R (B2 TM1) (6x4)	1998-09.05	AV	410x175	MERITOR	19090	MNG90900	MXM90900
FM12 64R (B2 TM1) (6x4)	1998-09.05	AR2	410x200	MERITOR	19071	MNG90710	MXM90710
FM12 64R (B2 TM1) (6x4)	1998-09.05	AR	410x200	MERITOR	19071	MNG90710	MXM90710
FM12 64T (B2 DR1/FR1) (6x4)	1998-09.05	AV	410x175	MERITOR	19090	MNG90900	MXM90900
FM12 64T (B2 DR1/FR1) (6x4)	1998-09.05	AR2	410x200	MERITOR	19071	MNG90710	MXM90710
FM12 64T (B2 DR1/FR1) (6x4)	1998-09.05	AR	410x200	MERITOR	19071	MNG90710	MXM90710
FM12 64T road (B2 PR1) (6x4)	1998-09.05	AV	410x175	MERITOR	19090	MNG90900	MXM90900
FM12 64T road (B2 PR1) (6x4)	1998-09.05	AR2	410x200	MERITOR	19071	MNG90710	MXM90710
FM12 64T road (B2 PR1) (6x4)	1998-09.05	AR	410x200	MERITOR	19071	MNG90710	MXM90710
FM12 82R (B2PK1) (8x2)	1998-09.05	AV	410x175	MERITOR	19090	MNG90900	MXM90900
FM12 82R (B2PK1) (8x2)	1998-09.05	AV2	410x175	MERITOR	19090	MNG90900	MXM90900
FM12 82R (B2PK1) (8x2)	1998-09.05	AR2	410x225	MERITOR	19068	MNG90680	MXM90680
FM12 82R (B2PK1) (8x2)	1998-09.05	AR	410x225	MERITOR	19068	MNG90680	MXM90680
FM12 84R (B2 DR1/DT1/MM1/MR1/MT1) (8x4)	1998-09.05	AV	410x175	MERITOR	19090	MNG90900	MXM90900
FM12 84R (B2 DR1/DT1/MM1/MR1/MT1) (8x4)	1998-09.05	AV2	410x175	MERITOR	19090	MNG90900	MXM90900
FM12 84R (B2 DR1/DT1/MM1/MR1/MT1) (8x4)	1998-09.05	AR2	410x200	MERITOR	19071	MNG90710	MXM90710
FM12 84R (B2 DR1/DT1/MM1/MR1/MT1) (8x4)	1998-09.05	AR	410x200	MERITOR	19071	MNG90710	MXM90710
FM12 84R (B2 PM1/PM3/PR1) (8x4)	1998-09.05	AV	410x175	MERITOR	19090	MNG90900	MXM90900

APPLICATION PAR MODELES

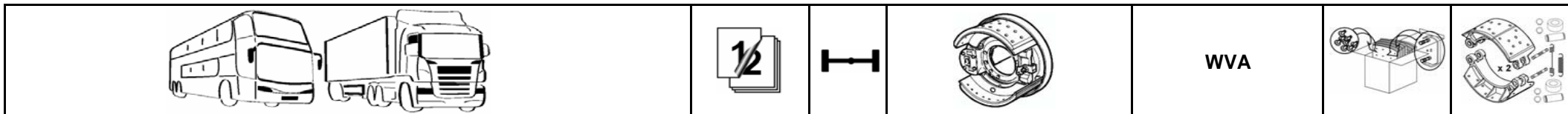

VOLVO TRUCKS/

FM 12/16/





FM12 84R (B2 PM1/PM3/PR1) (8x4)	1998-09.05	AV2	410x175	MERITOR	19090	MNG90900	MXM90900
FM12 84R (B2 PM1/PM3/PR1) (8x4)	1998-09.05	AR2	410x200	MERITOR	19071	MNG90710	MXM90710
FM12 84R (B2 PM1/PM3/PR1) (8x4)	1998-09.05	AR	410x200	MERITOR	19071	MNG90710	MXM90710

N - SERIE



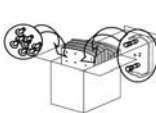

N7, N10, N12	1985-1993	AV	410x150	MERITOR	19941	MNG99410	MXM99410
N7, N10, N12	1985-1993	AV	410x175	MERITOR	19090	MNG90900	MXM90900
N7, N10, N12	1985-1993	AV	410x200	MERITOR	19071	MNG90710	MXM90710
N7, N10, N12	1985-1993	AV	410x225	MERITOR	19068	MNG90680	MXM90680
N7, N10, N12	1985-1993	AR	410x150	MERITOR	19941	MNG99410	MXM99410
N7, N10, N12	1985-1993	AR	410x175	MERITOR	19090	MNG90900	MXM90900
N7, N10, N12	1985-1993	AR	410x200	MERITOR	19071	MNG90710	MXM90710
N7, N10, N12	1985-1993	AR	410x225	MERITOR	19068	MNG90680	MXM90680

Automotive

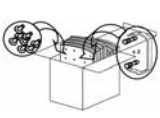

RECHERCHE PAR DIMENSIONS

				
360x170 BENDIX	RENAULT TRUCKS MIDLINER M/S, RVI	19255/19259	MNG92550	MXM92550
360x170 PERROT	DAF 50 F, 55 F; IVECO EURO CARGO	19503	MNG95030	MXM95030
410x125 MERITOR	VOLVO TRUCKS F12, F16, FH12, FH16, FL10, FL12, FL7, FM12, FM7	17992	MNG79920	MXM79920
410x150 MERITOR	VOLVO TRUCKS B-SERIE, F - SERIE, N - SERIE	19941	MNG99410	MXM99410
410x175 MERITOR	ERF E - SERIE; RENAULT TRUCKS KERAX; VOLVO TRUCKS B-SERIE, F - SERIE, FH 12/16, FL 12/16, FM 12/16, FM 7, N - SERIE	19090	MNG90900	MXM90900
410x180 PERROT 1	IVECO EUROT ECH MP	19342/19262		MXM90990
410x182 PERROT 2	IVECO EUROSTAR, EUROT ECH, EUROT ECH MP	19099/19100	MNG90990	MXM90990
410x180 ROCKWELL 1	IVECO EUROSTAR, EUROT ECH MP, EUROT ECH MT	19555/19556	MNG95550	MXM95550
410x180 ROCKWELL 2	IVECO EUROSTAR, EUROT ECH MP, EUROT ECH MT	19714/19715 /19556	MNG97140	MXM97140
410x200 MERITOR	ERF E - SERIE; IRISBUS RECREO 2; VOLVO TRUCKS B-SERIE, F - SERIE, FH 12/16, FM 12/16, FM 7, N - SERIE	19071	MNG90710	MXM90710
410x200 PERROT 1	IVECO EUROSTAR, EUROT ECH MP, EUROTRAKKER	19343/19263		MXM90910
410x202 PERROT 2	IVECO EUROSTAR, EUROT ECH, EUROT ECH MP	19091/19098	MNG90910	MXM90910
410x200 ROCKWELL 1	IVECO EUROSTAR, EUROT ECH MP, EUROT ECH MT, EUROTRAKKER	19554/19553	MNG95540	MXM95540
410x200 ROCKWELL 2	IVECO EUROSTAR, EUROT ECH MP, EUROT ECH MT, EUROTRAKKER	19716/19717 /19553	MNG97160	MXM97160
410x225 MERITOR	IRISBUS HEULIEZ; RENAULT TRUCKS KERAX; VOLVO TRUCKS B-SERIE, F - SERIE, FH 12/16, FL 12/16, FM 12/16, FM 7, N - SERIE	19068	MNG90680	MXM90680
412x127 SCANIA	SCANIA SERIE 3 - 93,113, 114, SERIE 4 - 94, 114, 124	17991	MNG79910	MXM79910
412x178 SCANIA	SCANIA C-K BUS, N - BUS, SERIE 3 - 93,113, 143, SERIE 4 - 94, 114, 124, 144	19931	MNG99310	MXM99310
412x203 SCANIA	SCANIA SERIE 3 - 93,113, 143, SERIE 4 - 94, 114, 124, 144	19932	MNG99320	MXM99320
412x254 SCANIA	SCANIA C-K BUS, N - BUS, SERIE 3 - 93,113, 143, SERIE 4 - 94, 114, 124, 144	19933	MNG99330	MXM99330
414x150 BENDIX	IRISBUS E - SERIE, HEULIEZ, PR, S - SERIE; RENAULT TRUCKS BERLIET, C - RANGE, G - MANAGER, MIDLINER M/S, R - MAJOR, SAVIEM	19049/19199	MNG90490	MXM90490
414x150 RT	RENAULT TRUCKS C - RANGE, G - MANAGER, MAGNUM AE, MIDLINER M/S, R - MAJOR	19934	MNG99340	MXM99340
414x175 RT	IRISBUS FR 1, HEULIEZ, PR, TRACER; RENAULT TRUCKS C - RANGE, G - MANAGER, G - MAXTER, MAGNUM AE, MIDLINER M/S, R - MAJOR	19935	MNG99350	MXM99350
414x175 RT	RENAULT TRUCKS KERAX	19935	MNG99350K	MXM99350K
414x200 RT	IRISBUS FR 1, PR	19974	MNG99740	MXM99740
414x220 RT	IRISBUS AGORA, FR 1, HEULIEZ, ILIADE; RENAULT TRUCKS MAGNUM AE, PREMIUM	19187	MNG91870	MXM91870
414x220 RT	RENAULT TRUCKS KERAX	19187	MNG91870K	MXM91870K
420x150 DAF	DAF 1900, 2300, 2500, 2700, 2900, 65 F, 75 F, 85 F, 95 F	19010/19011	MNG90100	MXM90100
420x200 DAF	DAF 2300, 2700, 2900, 65 F, 75 F, 85 F, 95 F	19063/19064	MNG90630	MXM90630

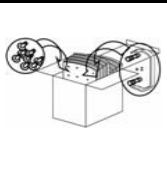

RECHERCHE PAR LE NUMÉRO WVA

WVA				
17991	412x127 SCANIA	SCANIA SERIE 3 - 93,113, 114, SERIE 4 - 94, 114, 124	MNG79910	MXM79910
17992	410x125 MERITOR	VOLVO TRUCKS F12, F16, FH12, FH16, FL10, FL12, FL7, FM12, FM7	MNG79920	MXM79920
19010/19011	420x150 DAF	DAF 1900, 2300, 2500, 2700, 2900, 65 F, 75 F, 85 F, 95 F	MNG90100	MXM90100
19049/19199	414x150 BENDIX	IRISBUS E - SERIE, HEULIEZ, PR, S - SERIE; RENAULT TRUCKS BERLIET, C - RANGE, G - MANAGER, MIDLINER M/S, R - MAJOR, SAVIEM	MNG90490	MXM90490
19063/19064	420x200 DAF	DAF 2300, 2700, 2900, 65 F, 75 F, 85 F, 95 F	MNG90630	MXM90630
19068	410x225 MERITOR	IRISBUS HEULIEZ; RENAULT TRUCKS KERAX; VOLVO TRUCKS B-SERIE, F - SERIE, FH 12/16, FL 12/16, FM 12/16, FM 7, N - SERIE	MNG90680	MXM90680
19071	410x200 MERITOR	ERF E - SERIE; IRISBUS RECREO 2; VOLVO TRUCKS B-SERIE, F - SERIE, FH 12/16, FM 12/16, FM 7, N - SERIE	MNG90710	MXM90710
19090	410x175 MERITOR	ERF E - SERIE; RENAULT TRUCKS KERAX; VOLVO TRUCKS B-SERIE, F - SERIE, FH 12/16, FL 12/16, FM 12/16, FM 7, N - SERIE	MNG90900	MXM90900
19091/19098	410x202 PERROT 2	IVECO EUROSTAR, EUROTECH, EUROTECH MP	MNG90910	MXM90910
19099/19100	410x182 PERROT 2	IVECO EUROSTAR, EUROTECH, EUROTECH MP	MNG90990	MXM90990
19187	414x220 RT	IRISBUS AGORA, FR 1, HEULIEZ, ILIADE; RENAULT TRUCKS MAGNUM AE, PREMIUM	MNG91870	MXM91870
19187	414x220 RT	RENAULT TRUCKS KERAX	MNG91870K	MXM91870K
19255/19259	360x170 BENDIX	RENAULT TRUCKS MIDLINER M/S, RVI	MNG92550	MXM92550
19342/19262	410x180 PERROT 1	IVECO EUROTECH MP		MXM90990
19343/19263	410x200 PERROT 1	IVECO EUROSTAR, EUROTECH MP, EUROTRAKKER		MXM90910
19503	360x170 PERROT	DAF 50 F, 55 F; IVECO EUROCARGO	MNG95030	MXM95030
19554/19553	410x200 ROCKWELL 1	IVECO EUROSTAR, EUROTECH MP, EUROTECH MT, EUROTRAKKER	MNG95540	MXM95540
19555/19556	410x180 ROCKWELL 1	IVECO EUROSTAR, EUROTECH MP, EUROTECH MT	MNG95550	MXM95550
19714/19715/ 19556	410x180 ROCKWELL 2	IVECO EUROSTAR, EUROTECH MP, EUROTECH MT	MNG97140	MXM97140
19716/19717/ 19553	410x200 ROCKWELL 2	IVECO EUROSTAR, EUROTECH MP, EUROTECH MT, EUROTRAKKER	MNG97160	MXM97160
19931	412x178 SCANIA	SCANIA C-K BUS, N - BUS, SERIE 3 - 93,113, 143, SERIE 4 - 94, 114, 124, 144	MNG99310	MXM99310
19932	412x203 SCANIA	SCANIA SERIE 3 - 93,113, 143, SERIE 4 - 94, 114, 124, 144	MNG99320	MXM99320
19933	412x254 SCANIA	SCANIA C-K BUS, N - BUS, SERIE 3 - 93,113, 143, SERIE 4 - 94, 114, 124, 144	MNG99330	MXM99330
19934	414x150 RT	RENAULT TRUCKS C - RANGE, G - MANAGER, MAGNUM AE, MIDLINER M/S, R - MAJOR	MNG99340	MXM99340
19935	414x175 RT	IRISBUS FR 1, HEULIEZ, PR, TRACER; RENAULT TRUCKS C - RANGE, G - MANAGER, G - MAXTER, MAGNUM AE, MIDLINER M/S, R - MAJOR	MNG99350	MXM99350
19935	414x175 RT	RENAULT TRUCKS KERAX	MNG99350K	MXM99350K
19941	410x150 MERITOR	VOLVO TRUCKS B-SERIE, F - SERIE, N - SERIE	MNG99410	MXM99410
19974	414x200 RT	IRISBUS FR 1, PR	MNG99740	MXM99740

LISTE NUMÉRIQUE

	DÉSIGNATION			WVA
MNG79910	Kit pour 1 essieu : garnitures, rivets, ressorts et accessoires de réparation de mâchoire. Côte origine	412x127 SCANIA	SCANIA SERIE 3 - 93,113, 114, SERIE 4 - 94, 114, 124	17991
MNG79920	Kit pour 1 essieu : garnitures, rivets, ressorts et accessoires de réparation de mâchoire. Côte origine	410x125 MERITOR	VOLVO TRUCKS F12, F16, FH12, FH16, FL10, FL12, FL7, FM12, FM7	17992
MNG90100	Kit pour 1 essieu : garnitures, rivets, ressorts et accessoires de réparation de mâchoire. Côte origine	420x150 DAF	DAF 1900, 2300, 2500, 2700, 2900, 65 F, 75 F, 85 F, 95 F	19010/19011
MNG90490	Kit pour 1 essieu : garnitures, rivets, ressorts et accessoires de réparation de mâchoire. Côte origine	414x150 BENDIX	IRISBUS E - SERIE, HEULIEZ, PR, S - SERIE; RENAULT TRUCKS BERLIET, C - RANGE, G - MANAGER, MIDLINER M/S, R - MAJOR, SAVIEM	19049/19199
MNG90630	Kit pour 1 essieu : garnitures, rivets, ressorts et accessoires de réparation de mâchoire. Côte origine	420x200 DAF	DAF 2300, 2700, 2900, 65 F, 75 F, 85 F, 95 F	19063/19064
MNG90680	Kit pour 1 essieu : garnitures, rivets, ressorts et accessoires de réparation de mâchoire. Côte origine	410x225 MERITOR	IRISBUS HEULIEZ; RENAULT TRUCKS KERAX; VOLVO TRUCKS B-SERIE, F - SERIE, FH 12/16, FL 12/16, FM 12/16, FM 7, N - SERIE	19068
MNG90710	Kit pour 1 essieu : garnitures, rivets, ressorts et accessoires de réparation de mâchoire. Côte origine	410x200 MERITOR	ERF E - SERIE; IRISBUS RECREO 2; VOLVO TRUCKS B-SERIE, F - SERIE, FH 12/16, FM 12/16, FM 7, N - SERIE	19071
MNG90900	Kit pour 1 essieu : garnitures, rivets, ressorts et accessoires de réparation de mâchoire. Côte origine	410x175 MERITOR	ERF E - SERIE; RENAULT TRUCKS KERAX; VOLVO TRUCKS B-SERIE, F - SERIE, FH 12/16, FL 12/16, FM 12/16, FM 7, N - SERIE	19090
MNG90910	Kit pour 1 essieu : garnitures, rivets, ressorts et accessoires de réparation de mâchoire. Côte origine	410x202 PERROT 2	IVECO EUROSTAR, EUROTECH, EUROTECH MP	19091/19098
MNG90990	Kit pour 1 essieu : garnitures, rivets, ressorts et accessoires de réparation de mâchoire. Côte origine	410x182 PERROT 2	IVECO EUROSTAR, EUROTECH, EUROTECH MP	19099/19100
MNG91870	Kit pour 1 essieu : garnitures, rivets, ressorts et accessoires de réparation de mâchoire. Côte origine	414x220 RT	IRISBUS AGORA, FR 1, HEULIEZ, ILIADE; RENAULT TRUCKS MAGNUM AE, PREMIUM	19187
MNG91870K	Kit pour 1 essieu : garnitures, rivets, ressorts et accessoires de réparation de mâchoire. Côte origine	414x220 RT	RENAULT TRUCKS KERAX	19187
MNG92550	Kit pour 1 essieu : garnitures, rivets, ressorts et accessoires de réparation de mâchoire. Côte origine	360x170 BENDIX	RENAULT TRUCKS MIDLINER M/S, RVI	19255/19259

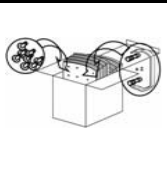
LISTE NUMÉRIQUE

	DÉSIGNATION			WVA
MNG95030	Kit pour 1 essieu : garnitures, rivets, ressorts et accessoires de réparation de mâchoire. Côte origine	360x170 PERROT	DAF 50 F, 55 F; IVECO EURO CARGO	19503
MNG95540	Kit pour 1 essieu : garnitures, rivets, ressorts et accessoires de réparation de mâchoire. Côte origine	410x200 ROCKWELL 1	IVECO EUROSTAR, EUROTÉCH MP, EUROTÉCH MT, EUROTRAKKER	19554/19553
MNG95550	Kit pour 1 essieu : garnitures, rivets, ressorts et accessoires de réparation de mâchoire. Côte origine	410x180 ROCKWELL 1	IVECO EUROSTAR, EUROTÉCH MP, EUROTÉCH MT	19555/19556
MNG97140	Kit pour 1 essieu : garnitures, rivets, ressorts et accessoires de réparation de mâchoire. Côte origine	410x180 ROCKWELL 2	IVECO EUROSTAR, EUROTÉCH MP, EUROTÉCH MT	19714/19715 /19556
MNG97160	Kit pour 1 essieu : garnitures, rivets, ressorts et accessoires de réparation de mâchoire. Côte origine	410x200 ROCKWELL 2	IVECO EUROSTAR, EUROTÉCH MP, EUROTÉCH MT, EUROTRAKKER	19716/19717 /19553
MNG99310	Kit pour 1 essieu : garnitures, rivets, ressorts et accessoires de réparation de mâchoire. Côte origine	412x178 SCANIA	SCANIA C-K BUS, N - BUS, SERIE 3 - 93,113, 143, SERIE 4 - 94, 114, 124, 144	19931
MNG99320	Kit pour 1 essieu : garnitures, rivets, ressorts et accessoires de réparation de mâchoire. Côte origine	412x203 SCANIA	SCANIA SERIE 3 - 93,113, 143, SERIE 4 - 94, 114, 124, 144	19932
MNG99330	Kit pour 1 essieu : garnitures, rivets, ressorts et accessoires de réparation de mâchoire. Côte origine	412x254 SCANIA	SCANIA C-K BUS, N - BUS, SERIE 3 - 93,113, 143, SERIE 4 - 94, 114, 124, 144	19933
MNG99340	Kit pour 1 essieu : garnitures, rivets, ressorts et accessoires de réparation de mâchoire. Côte origine	414x150 RT	RENAULT TRUCKS C - RANGE, G - MANAGER, MAGNUM AE, MIDLINER M/S, R - MAJOR	19934
MNG99350	Kit pour 1 essieu : garnitures, rivets, ressorts et accessoires de réparation de mâchoire. Côte origine	414x175 RT	IRISBUS FR 1, HEULIEZ, PR, TRACER; RENAULT TRUCKS C - RANGE, G - MANAGER, G - MAXTER, MAGNUM AE, MIDLINER M/S, R - MAJOR	19935
MNG99350K	Kit pour 1 essieu : garnitures, rivets, ressorts et accessoires de réparation de mâchoire. Côte origine	414x175 RT	RENAULT TRUCKS KERAX	19935
MNG99410	Kit pour 1 essieu : garnitures, rivets, ressorts et accessoires de réparation de mâchoire. Côte origine	410x150 MERITOR	VOLVO TRUCKS B-SERIE, F - SERIE, N - SERIE	19941
MNG99740	Kit pour 1 essieu : garnitures, rivets, ressorts et accessoires de réparation de mâchoire. Côte origine	414x200 RT	IRISBUS FR 1, PR	19974

LISTE NUMÉRIQUE

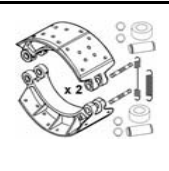
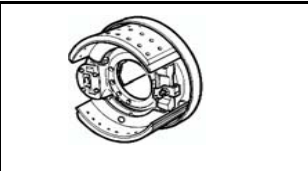
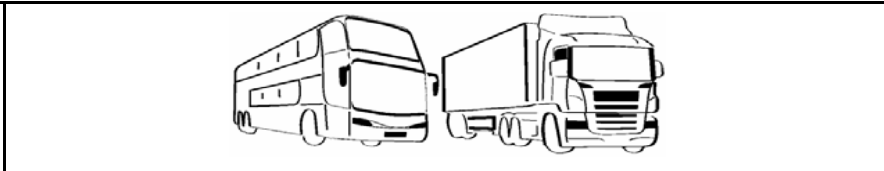
	DÉSIGNATION			WVA
MXM79910	Kit pour 1 essieu : mâchoires neuves garnies, ressorts et accessoires. Côte origine	412x127 SCANIA	SCANIA SERIE 3 - 93,113, 114, SERIE 4 - 94, 114, 124	17991
MXM79920	Kit pour 1 essieu : mâchoires neuves garnies, ressorts et accessoires. Côte origine	410x125 MERITOR	VOLVO TRUCKS F12, F16, FH12, FH16, FL10, FL12, FL7, FM12, FM7	17992
MXM90100	Kit pour 1 essieu : mâchoires neuves garnies, ressorts et accessoires. Côte origine	420x150 DAF	DAF 1900, 2300, 2500, 2700, 2900, 65 F, 75 F, 85 F, 95 F	19010/19011
MXM90490	Kit pour 1 essieu : mâchoires neuves garnies, ressorts et accessoires. Côte origine	414x150 BENDIX	IRISBUS E - SERIE, HEULIEZ, PR, S - SERIE; RENAULT TRUCKS BERLIET, C - RANGE, G - MANAGER, MIDLINER M/S, R - MAJOR, SAVIEM	19049/19199
MXM90630	Kit pour 1 essieu : mâchoires neuves garnies, ressorts et accessoires. Côte origine	420x200 DAF	DAF 2300, 2700, 2900, 65 F, 75 F, 85 F, 95 F	19063/19064
MXM90680	Kit pour 1 essieu : mâchoires neuves garnies, ressorts et accessoires. Côte origine	410x225 MERITOR	IRISBUS HEULIEZ; RENAULT TRUCKS KERAX; VOLVO TRUCKS B-SERIE, F - SERIE, FH 12/16, FL 12/16, FM 12/16, FM 7, N - SERIE	19068
MXM90710	Kit pour 1 essieu : mâchoires neuves garnies, ressorts et accessoires. Côte origine	410x200 MERITOR	ERF E - SERIE; IRISBUS RECREO 2; VOLVO TRUCKS B-SERIE, F - SERIE, FH 12/16, FM 12/16, FM 7, N - SERIE	19071
MXM90900	Kit pour 1 essieu : mâchoires neuves garnies, ressorts et accessoires. Côte origine	410x175 MERITOR	ERF E - SERIE; RENAULT TRUCKS KERAX; VOLVO TRUCKS B-SERIE, F - SERIE, FH 12/16, FL 12/16, FM 12/16, FM 7, N - SERIE	19090
MXM90910	Kit pour 1 essieu : mâchoires neuves garnies, ressorts et accessoires. Côte origine	410x202 PERROT 2	IVECO EUROSTAR, EUROTECH, EUROTECH MP	19091/19098
MXM90910	Kit pour 1 essieu : mâchoires neuves garnies, ressorts et accessoires. Côte origine	410x200 PERROT 1	IVECO EUROSTAR, EUROTECH MP, EUROTRAKKER	19343/19263
MXM90990	Kit pour 1 essieu : mâchoires neuves garnies, ressorts et accessoires. Côte origine	410x182 PERROT 2	IVECO EUROSTAR, EUROTECH, EUROTECH MP	19099/19100
MXM90990	Kit pour 1 essieu : mâchoires neuves garnies, ressorts et accessoires. Côte origine	410x180 PERROT 1	IVECO EUROTECH MP	19342/19262
MXM91870	Kit pour 1 essieu : mâchoires neuves garnies, ressorts et accessoires. Côte origine	414x220 RT	IRISBUS AGORA, FR 1, HEULIEZ, ILIADE; RENAULT TRUCKS MAGNUM AE, PREMIUM	19187
MXM91870K	Kit pour 1 essieu : mâchoires neuves garnies, ressorts et accessoires. Côte origine	414x220 RT	RENAULT TRUCKS KERAX	19187

LISTE NUMÉRIQUE

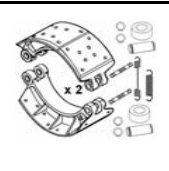
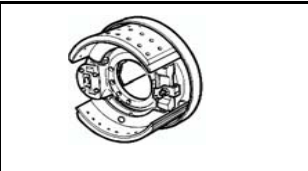
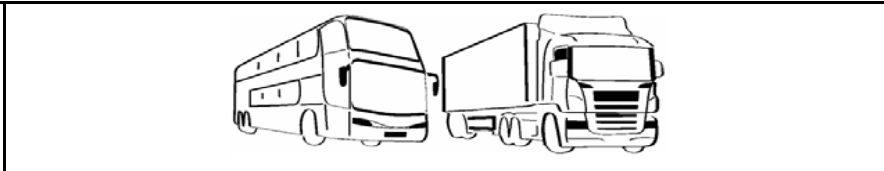
	DÉSIGNATION			WVA
MXM92550	Kit pour 1 essieu : mâchoires neuves garnies, ressorts et accessoires. Côte origine	360x170 BENDIX	RENAULT TRUCKS MIDLINER M/S, RVI	19255/19259
MXM95030	Kit pour 1 essieu : mâchoires neuves garnies, ressorts et accessoires. Côte origine	360x170 PERROT	DAF 50 F, 55 F; IVECO EUROCARGO	19503
MXM95540	Kit pour 1 essieu : mâchoires neuves garnies, ressorts et accessoires. Côte origine	410x200 ROCKWELL 1	IVECO EUROSTAR, EUROTECH MP, EUROTECH MT, EUROTRAKKER	19554/19553
MXM95550	Kit pour 1 essieu : mâchoires neuves garnies, ressorts et accessoires. Côte origine	410x180 ROCKWELL 1	IVECO EUROSTAR, EUROTECH MP, EUROTECH MT	19555/19556
MXM97140	Kit pour 1 essieu : mâchoires neuves garnies, ressorts et accessoires. Côte origine	410x180 ROCKWELL 2	IVECO EUROSTAR, EUROTECH MP, EUROTECH MT	19714/19715/ 19556
MXM97160	Kit pour 1 essieu : mâchoires neuves garnies, ressorts et accessoires. Côte origine	410x200 ROCKWELL 2	IVECO EUROSTAR, EUROTECH MP, EUROTECH MT, EUROTRAKKER	19716/19717/ 19553
MXM99310	Kit pour 1 essieu : mâchoires neuves garnies, ressorts et accessoires. Côte origine	412x178 SCANIA	SCANIA C-K BUS, N - BUS, SERIE 3 - 93,113, 143, SERIE 4 - 94, 114, 124, 144	19931
MXM99320	Kit pour 1 essieu : mâchoires neuves garnies, ressorts et accessoires. Côte origine	412x203 SCANIA	SCANIA SERIE 3 - 93,113, 143, SERIE 4 - 94, 114, 124, 144	19932
MXM99330	Kit pour 1 essieu : mâchoires neuves garnies, ressorts et accessoires. Côte origine	412x254 SCANIA	SCANIA C-K BUS, N - BUS, SERIE 3 - 93,113, 143, SERIE 4 - 94, 114, 124, 144	19933
MXM99340	Kit pour 1 essieu : mâchoires neuves garnies, ressorts et accessoires. Côte origine	414x150 RT	RENAULT TRUCKS C - RANGE, G - MANAGER, MAGNUM AE, MIDLINER M/S, R - MAJOR	19934
MXM99350	Kit pour 1 essieu : mâchoires neuves garnies, ressorts et accessoires. Côte origine	414x175 RT	IRISBUS FR 1, HEULIEZ, PR, TRACER; RENAULT TRUCKS C - RANGE, G - MANAGER, G - MAXTER, MAGNUM AE, MIDLINER M/S, R - MAJOR	19935
MXM99350K	Kit pour 1 essieu : mâchoires neuves garnies, ressorts et accessoires. Côte origine	414x175 RT	RENAULT TRUCKS KERAX	19935
MXM99410	Kit pour 1 essieu : mâchoires neuves garnies, ressorts et accessoires. Côte origine	410x150 MERITOR	VOLVO TRUCKS B-SERIE, F - SERIE, N - SERIE	19941
MXM99740	Kit pour 1 essieu : mâchoires neuves garnies, ressorts et accessoires. Côte origine	414x200 RT	IRISBUS FR 1, PR	19974

CORRESPONDANCES DE REFERENCE

MARQUE	OES	DESIGNATION	REFERENCE
ASTRA	113303	MACHOIRE GARNIE	MAG0001
ASTRA	113304	MACHOIRE GARNIE	MAG0002
ASTRA	113305	MACHOIRE GARNIE	MAG0003
ASTRA	159038	FREIN DUPLEX 410X200	FCD010
ASTRA	159040	FREIN DUPLEX 410X200	FCD009
DAF	1785125	JEU GARNITURES DAF 200 (420) NM	19063/6400AF/710
DAF	1785126	JEU GARNITURES DAF 200 (420) NM	19063/6400AF/710
DAF	682857	JEU GARNITURES DAF 150 (420) AM	19010/1100AF/710
DAF	682861	JEU GARNITURES DAF 200 (420) NM	19063/6400AF/710
DAF	683033	JEU GARNITURES DAF 150 (420) AM	19010/1100AF/710
DAF	683037	JEU GARNITURES DAF 200 (420) NM	19063/6400AF/710
DAF	683274	JEU GARNITURES DAF 150 (420) AM	19010/1100AF/710
DAF	683278	JEU GARNITURES DAF 200 (420) NM	19063/6400AF/710
IRISBUS	5006018433	ARBRE DE COMMANDE	CAM001
IRISBUS	5006018434	ARBRE DE COMMANDE	CAM002
IVECO	123755	FREIN SIMPLEX 410X200 DROIT	FCS012
IVECO	123756	FREIN SIMPLEX 410X200 GAUCHE	FCS011
IVECO	1906032	KIT MACHOIRES 381X178 STD0	MAK0001
IVECO	1906033	KIT MACHOIRES 381X178 +1	MAK0002
IVECO	1906034	KIT MACHOIRES 381X178 +2	MAK0003
IVECO	1906374	JEU GARNITURES IVECO 200 (410)	19553/55400AF/710
IVECO	1906383	KIT MACHOIRES 381X178 STD0	MAK0004
IVECO	1906384	KIT MACHOIRES 381X178 +1	MAK0005
IVECO	1906385	KIT MACHOIRES 381X178 +2	MAK0006
IVECO	1906404	KIT MACHOIRES 410x180 STD0	MAK0010
IVECO	1906410	KIT MACHOIRES 410x200 STD0	MAK0007
IVECO	1906411	KIT MACHOIRES 410x200 +1	MAK0008
IVECO	1906412	KIT MACHOIRES 410x200 +2	MAK0009
IVECO	1906470	KIT MACHOIRES 381X178 STD0	MAK0004
IVECO	1906471	KIT MACHOIRES 381X178 +1	MAK0005
IVECO	1906472	KIT MACHOIRES 381X178 +2	MAK0006
IVECO	2991624	KIT MACHOIRES 410x180 STD0	MAK0012
IVECO	2991630	KIT MACHOIRES 410x200 STD0	MAK0014
IVECO	2991631	KIT MACHOIRES 410X200	MAK0015
IVECO	2991759	JEU REPARATION	MAK0016
IVECO	3395088	KIT DE RÉGLAGE SIMPLIFIÉ	ACK008
IVECO	41022771	FREIN SIMPLEX 410X180 GAUCHE	FCS005
IVECO	41022772	FREIN SIMPLEX 410X180 DROIT	FCS006
IVECO	41022773	FREIN SIMPLEX 410X200 GAUCHE	FCS009
IVECO	41022774	FREIN SIMPLEX 410X200 DROIT	FCS010
IVECO	41025289	FREIN SIMPLEX 410X200 GAUCHE	FCS011
IVECO	41025290	FREIN SIMPLEX 410X200 DROIT	FCS012
IVECO	41211315	FREIN DUPLEX 410X180 GAUCHE	FCD005
IVECO	41211316	FREIN DUPLEX 410X180 DROIT	FCD006
IVECO	41211321	FREIN DUPLEX 410X200 GAUCHE	FCD011
IVECO	41211322	FREIN DUPLEX 410X200 DROIT	FCD012

CORRESPONDANCES DE REFERENCE

MARQUE	OES	DESIGNATION	REFERENCE
IVECO	41285034	FREIN DUPLEX 410X200 GAUCHE	FCD011
IVECO	41285035	FREIN DUPLEX 410X200 DROIT	FCD012
IVECO	42491950	KIT DE RÉGLAGE COMPLET	ACK009
IVECO	42536194	KIT DE RÉGLAGE SIMPLIFIÉ	ACK013
IVECO	42537942	KIT DE RÉGLAGE SIMPLIFIÉ	ACK012
IVECO	42538063	KIT RESSORT DE RAPPEL	ACK020
IVECO	42538064	KIT CLIP DE FIXATION	ACK004
IVECO	42538065	KIT DE RÉGLAGE COMPLET	ACK010
IVECO	42538068	KIT TEMOIN D'USURE	TUK001
IVECO	42558432	COMPLETE ADJUSTER KITS	ACK006
IVECO	42559512	COMPLETE ADJUSTER KITS	ACK006
IVECO	4860637	FREIN DUPLEX 381X178 GAUCHE	FCD003
IVECO	4860638	FREIN DUPLEX 381X178 DROIT	FCD004
IVECO	500351600	FREIN SIMPLEX 381 GAUCHE	FCS001
IVECO	500351601	FREIN SIMPLEX 381 DROIT	FCS002
IVECO	500359913	FREIN SIMPLEX 360 X 170 GAUCHE	FCS003
IVECO	500359916	FREIN SIMPLEX 360 X 170 DROIT	FCS004
IVECO	7980405	KIT PLONGEUR D'ANCRAGE	ACK015
IVECO	7980406	KIT PLONGEUR D'ANCRAGE	ACK016
IVECO	7980407	KIT DE RÉGLAGE SIMPLIFIÉ	ACK011
IVECO	7980408	KIT JOINT D'ÉTANCHÉITÉ	ACK014
IVECO	7980687	KIT CLIP DE FIXATION	ACK002
IVECO	93161621	KIT DE RÉGLAGE SIMPLIFIÉ	ACK008
IVECO	93161622	KIT COIN COMPLET	ACK005
IVECO	93161623	KIT COIN SIMPLIFIE	ACK007
IVECO	93161625	KIT JOINT D'ÉTANCHÉITÉ	ACK015
IVECO	93161626	KIT CLIP DE FIXATION	ACK003
IVECO	93161627	KIT RESSORT DE RAPPEL	ACK021
IVECO	93161863	KIT PLONGEUR D'ANCRAGE	ACK017
IVECO	93161864	KIT PLONGEUR D'ANCRAGE	ACK018
IVECO	93162113	KIT RESSORT DE RAPPEL	ACK021
IVECO	93162114	KIT COIN COMPLET	ACK005
IVECO	93163853	TEMOIN D'USURE 1ER SERIE	TU0001
IVECO	93192921	TEMOIN D'USURE L1310	TU0002
IVECO	93192922	CLIP (CLIP)	AC0017
IVECO	93193778	TEMOIN D'USURE L955	TU0003
IVECO	98464849	FREIN DUPLEX 381X178 GAUCHE	FCD003
IVECO	98464850	FREIN DUPLEX 381X178 DROIT	FCD004
IVECO	98474483	FREIN SIMPLEX 381 GAUCHE	FCS001
IVECO	98474485	FREIN SIMPLEX 381 DROIT	FCS002
RENAULT TRUCKS	5000288508	JEU GARNITURES RVI 175 (414) NM	1993500AF/700
RENAULT TRUCKS	5000288512	JEU GARNITURES RVI 150 (414) NM	1993400AF/700
RENAULT TRUCKS	5000792794	MACHOIRE NUE RT 414X150	MAC9934
RENAULT TRUCKS	5000792795	MACHOIRE NUE RT 414X175	MAC9935
RENAULT TRUCKS	5000811113	JEU GARNITURES RVI 175 (414) NM	1993500AF/700
RENAULT TRUCKS	5000812335	JEU GARNITURES RVI 150 (414) NM	1993400AF/700

CORRESPONDANCES DE REFERENCE

MARQUE	OES	DESIGNATION	REFERENCE
RENAULT TRUCKS	5000815484	ECARTEUR FREIN COIN RT 360X170-310X125-325X150	AB337276
RENAULT TRUCKS	5000820588	MACHOIRE NUE RT 360X170	AB337220
RENAULT TRUCKS	5000821815	JEU GARNITURES RVI 150 (414) NM	1993400AF/700
RENAULT TRUCKS	5000821817	JEU GARNITURES RVI 220 (414)	1918700AF/710
RENAULT TRUCKS	5000821818	JEU GARNITURES RVI 220 (414) +1MM	1918710AF/710
RENAULT TRUCKS	5000822061	JEU GARNITURES RVI 150 (414) NM	1993400AF/700
RENAULT TRUCKS	5000825257	JEU GARNITURES RVI 150 (414) NM	1993400AF/700
RENAULT TRUCKS	5001019221	JEU GARNITURES RVI 175 (414) NM	1993500AF/700
RENAULT TRUCKS	5001019222	JEU GARNITURES RVI 220 (414)	1918700AF/710
RENAULT TRUCKS	5001823154	MACHOIRE NUE RT 310X125	AB350929
RENAULT TRUCKS	5001823158	MACHOIRE NUE RT 325X150	AB350891
RENAULT TRUCKS	5001823240	JEU GARNITURES RVI 220 (414)	1918700AF/710
RENAULT TRUCKS	5001823241	JEU GARNITURES RVI 220 (414) +1MM	1918710AF/710
RENAULT TRUCKS	5001825100	JEU GARNITURES RVI 175 (414) NM	1993500AF/700
RENAULT TRUCKS	5001855104	JEU GARNITURES RVI 150 (414) NM	1993400AF/700
RENAULT TRUCKS	5001855106	JEU GARNITURES RVI 175 (414) NM	1993500AF/700
RENAULT TRUCKS	5001855122	JEU GARNITURES RVI 220 (414)	1918700AF/710
RENAULT TRUCKS	5001855122	JEU GARNITURES RVI 175 (414) NM	1993500AF/700
RENAULT TRUCKS	5001855123	JEU GARNITURES RVI 220 (414) +1MM	1918710AF/710
RENAULT TRUCKS	5001855146	JEU GARNITURES RVI 220 (414)	1918700AF/710
RENAULT TRUCKS	5001855147	JEU GARNITURES RVI 220 (414) +1MM	1918710AF/710
RENAULT TRUCKS	5001860032	JEU GARNITURES RVI 175 (414) NM	1993500AF/700
RENAULT TRUCKS	5001860048	JEU GARNITURES RVI 220 (414)	1918700AF/700
RENAULT TRUCKS	5001860048	JEU GARNITURES RVI 220 (414)	1918700AF/710
RENAULT TRUCKS	5001868087	JEU GARNITURES VOLVO 175 Z (410)	1909000AF/710
RENAULT TRUCKS	5001868088	JEU GARNITURES VOLVO 175 Z (410) +1MM	1909010AF/710
RENAULT TRUCKS	5001868089	JEU GARNITURES VOLVO 200 Z (410)	1907100AF/710
RENAULT TRUCKS	5001868090	JEU GARNITURES VOLVO 200 Z (410) +1MM	1907110AF/710
RENAULT TRUCKS	5001868091	JEU GARNITURES VOLVO 225 Z (410)	1906800AF/710
RENAULT TRUCKS	5001868113	ANNEAU ÉLASTIQUE (SEGMENT)	AC0013
RENAULT TRUCKS	5001868114	PION DE BUTÉE	AC0016
RENAULT TRUCKS	5001868117	KIT DE RÉGLAGE GAUCHE AUTOMATIQUE	AC0006
RENAULT TRUCKS	5001868118	KIT DE RÉGLAGE DROIT AUTOMATIQUE	AC0005
RENAULT TRUCKS	5001868119	CACHE - POUSSIÈRE	AC0014
RENAULT TRUCKS	5001868120	JAMBE	AC0007
RENAULT TRUCKS	5001868121	KIT D'AXE TRANSVERSAL	AC0001
RENAULT TRUCKS	5001868122	ROULEMENT	AC0012
RENAULT TRUCKS	5001868125	PINION GAUCHE	AC0010
RENAULT TRUCKS	5001868126	PINION DROIT	AC0011
RENAULT TRUCKS	5001868127	PLAQUE COUVERCLE	AC0009
RENAULT TRUCKS	5001868128	AGRAFE À RESSORT	AC0015
RENAULT TRUCKS	5001868569	KIT 2 MACHOIRES NUES 175MM	MAC9090/2
RENAULT TRUCKS	5001868572	KIT 2 MACHOIRES NUES 200MM	MAC9071/2
RENAULT TRUCKS	5001868573	KIT 2 MACHOIRES NUES 225MM	MAC9068/2
RENAULT TRUCKS	5010097089	RESSORT DE MACHOIRES RT	RES002
RENAULT TRUCKS	5010097260	MACHOIRE NUE RT 414X175 KERAX	MAC9935K

CORRESPONDANCES DE REFERENCE

MARQUE	OES	DESIGNATION	REFERENCE
RENAULT TRUCKS	5010097262	AXE RESSORT RT	AXE002
RENAULT TRUCKS	5010097340	RESSORT DE MACHOIRES RT	RES001
RENAULT TRUCKS	5010098946	AXE RESSORT RT	AXE001
RENAULT TRUCKS	5010098948	MACHOIRE NUE RT 414X220 KERAX	MAC9187K
RENAULT TRUCKS	5010224629	MACHOIRE NUE IRISBUS 414X200	MAC9974
RENAULT TRUCKS	5010525775	MACHOIRE NUE RT 414X220	MAC9187
RENAULT TRUCKS	7400276097	KIT DE VERROUILLAGE DE RÉGLEUR	AC0003
RENAULT TRUCKS	7400276098	KIT DE VERROUILLAGE DE RÉGLEUR	AC0004
RENAULT TRUCKS	7403090964	KIT DE TIGE MANUELLE	AC0002
RENAULT TRUCKS	7703002134	VIS NOYÉE	AC0008
SCANIA	1109002	JEU GARNITURES SCANIA 178 (412,8)	1993100AF/710
SCANIA	1535247	JEU GARNITURES SCANIA 127 (412,8)	1799100AF/710
SCANIA	1535248	JEU GARNITURES SCANIA 178 (412,8)	1993100AF/710
SCANIA	1535249	JEU GARNITURES SCANIA 203 (412,8)	1993200AF/710
SCANIA	1535250	JEU GARNITURES SCANIA 254 (412,8)	1993300AF/710
SCANIA	551123	JEU GARNITURES SCANIA 178 (412,8)	1993100AF/710
SCANIA	551124	JEU GARNITURES SCANIA 203 (412,8)	1993200AF/710
SCANIA	551125	JEU GARNITURES SCANIA 254 (412,8)	1993300AF/710
SCANIA	551136	JEU GARNITURES SCANIA 127 (412,8)	1799100AF/710
SCANIA	551137	JEU GARNITURES SCANIA 178 (412,8)	1993100AF/710
SCANIA	551138	JEU GARNITURES SCANIA 203 (412,8)	1993200AF/710
SCANIA	551139	JEU GARNITURES SCANIA 254 (412,8)	1993300AF/710
SCANIA	551160	JEU GARNITURES SCANIA 127 (412,8)	1799100AF/710
SCANIA	551161	JEU GARNITURES SCANIA 178 (412,8)	1993100AF/710
SCANIA	551162	JEU GARNITURES SCANIA 203 (412,8)	1993200AF/710
SCANIA	551163	JEU GARNITURES SCANIA 254 (412,8)	1993300AF/710
SCANIA	551169	JEU GARNITURES SCANIA 178 (412,8)	1993100AF/710
SCANIA	551191	JEU GARNITURES SCANIA 127 (412,8)	1799100AF/710
SCANIA	552110	JEU GARNITURES SCANIA 127 (412,8)	1799100AF/710
VOLVO	270384	JEU GARNITURES VOLVO 175 Z (410)	1909000AF/710
VOLVO	270832	JEU GARNITURES VOLVO 150 Z (410)	1994100AF/710
VOLVO	2708329	JEU GARNITURES VOLVO 150 Z (410)	1994100AF/710
VOLVO	270838	JEU GARNITURES VOLVO 225 Z (410)	1906800AF/710
VOLVO	2708386	JEU GARNITURES VOLVO 225 Z (410)	1906800AF/710
VOLVO	2709368	JEU GARNITURES VOLVO 125 Z (410)	1799200AF/710
VOLVO	2709382	JEU GARNITURES VOLVO 150 Z (410)	1994100AF/710
VOLVO	2709384	JEU GARNITURES VOLVO 150 Z (410)	1994100AF/710
VOLVO	2709426	JEU GARNITURES VOLVO 200 Z (410)	1907100AF/710
VOLVO	2709442	JEU GARNITURES VOLVO 225 Z (410)	1906800AF/710
VOLVO	2709442	JEU GARNITURES VOLVO 225 Z (410)	1906800AF/710
VOLVO	270972	JEU GARNITURES VOLVO 150 Z (410)	1994100AF/710
VOLVO	2709723	JEU GARNITURES VOLVO 150 Z (410)	1994100AF/710
VOLVO	270978	JEU GARNITURES VOLVO 225 Z (410)	1906800AF/710
VOLVO	272910	KIT D'AXE TRANSVERSAL	AC0001
VOLVO	2759900	JEU GARNITURES VOLVO 125 Z (410)	1799200AF/710
VOLVO	2759926	JEU GARNITURES VOLVO 150 Z (410)	1994100AF/710

CORRESPONDANCES DE REFERENCE

MARQUE	OES	DESIGNATION	REFERENCE
VOLVO	2759967	JEU GARNITURES VOLVO 200 Z (410)	1907100AF/710
VOLVO	2759983	JEU GARNITURES VOLVO 225 Z (410)	1906800AF/710
VOLVO	276097	KIT DE VERROUILLAGE DE RÉGLEUR	AC0003
VOLVO	276098	KIT DE VERROUILLAGE DE RÉGLEUR	AC0004
VOLVO	276100	KIT DE TIGE MANUELLE	AC0002
VOLVO	3090345	JEU GARNITURES VOLVO 150 Z (410)	1994100AF/710
VOLVO	3090349	JEU GARNITURES VOLVO 200 Z (410)	1907100AF/710
VOLVO	30903512	JEU GARNITURES VOLVO 225 Z (410)	1906800AF/710
VOLVO	3091458	JEU GARNITURES VOLVO 200 Z (410)	1907100AF/710
VOLVO	3093260	JEU GARNITURES VOLVO 200 Z (410) +1MM	1907110AF/710
VOLVO	3093264	JEU GARNITURES VOLVO 200 Z (410) +1MM	1907110AF/710
VOLVO	3095163	JEU GARNITURES VOLVO 125 Z (410)	1799200AF/710
VOLVO	3095170	JEU GARNITURES VOLVO 200 Z (410) +1MM	1907110AF/710
VOLVO	3095173	JEU GARNITURES VOLVO 125 Z (410)	1799200AF/710
VOLVO	3095174	JEU GARNITURES VOLVO 125 Z (410)	1799200AF/710
VOLVO	3095177	JEU GARNITURES VOLVO 175 Z (410)	1909000AF/710
VOLVO	3095178	JEU GARNITURES VOLVO 175 Z (410)	1909000AF/710
VOLVO	3095180	JEU GARNITURES VOLVO 200 Z (410) +1MM	1907110AF/710
VOLVO	3097274	JEU GARNITURES VOLVO 125 Z (410)	1799200AF/710
VOLVO	3098264	JEU GARNITURES VOLVO 175 Z (410)	1909000AF/710
VOLVO	85105382	JEU GARNITURES VOLVO 175 Z (410)	1909000AF/710
VOLVO	85105383	JEU GARNITURES VOLVO 200 Z (410) +1MM	1907110AF/710
VOLVO	8550977	KIT DE RÉGLAGE DROIT AUTOMATIQUE	AC0005



**CATALOGUE PIÈCES DE FRICTIONS A TAM-BOURS POIDS LOURDS
MÂCHOIRES DE FREIN GARNIES ET KIT DE
GARNITURES AVEC ACCESSOIRES**

**CATALOG FOR CV FRICTIONS DRUM PART
CV LINED BRAKE SHOES AND CV LINING KIT
WITH FITTING KIT**

MAXIKIT FRICTION

MINIKIT FRICTION

Les autres pièces du frein

Vous pouvez obtenir auprès de votre distributeur les pièces détachées composantes pour votre frein.

Il est important pour garder votre matériel en fonction de vérifier à chaque changement de garnitures les autres pièces composantes du frein.

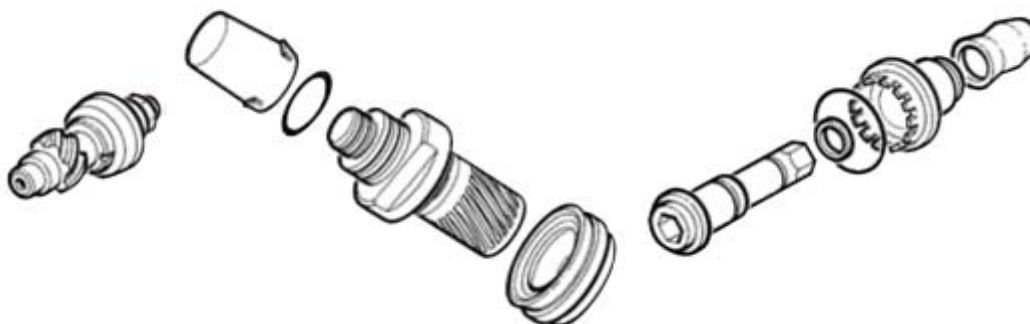

CACHET DU DISTRIBUTEUR

